

A ←
page 3/6



EXC 250-300 2005

CDI - charging circuit

2/6

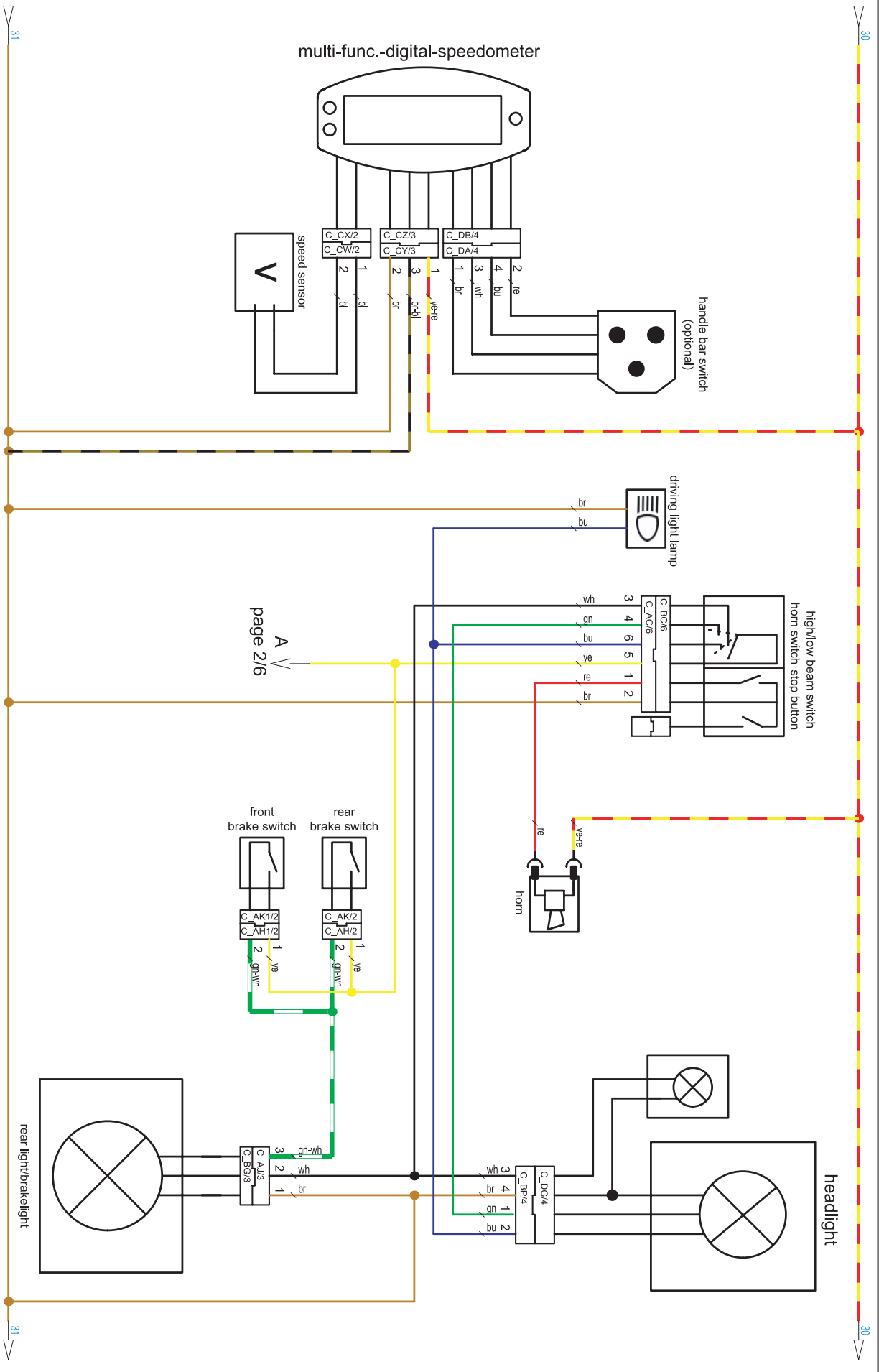

A V



EXC 250-300 2005

turn indicator system

4/6

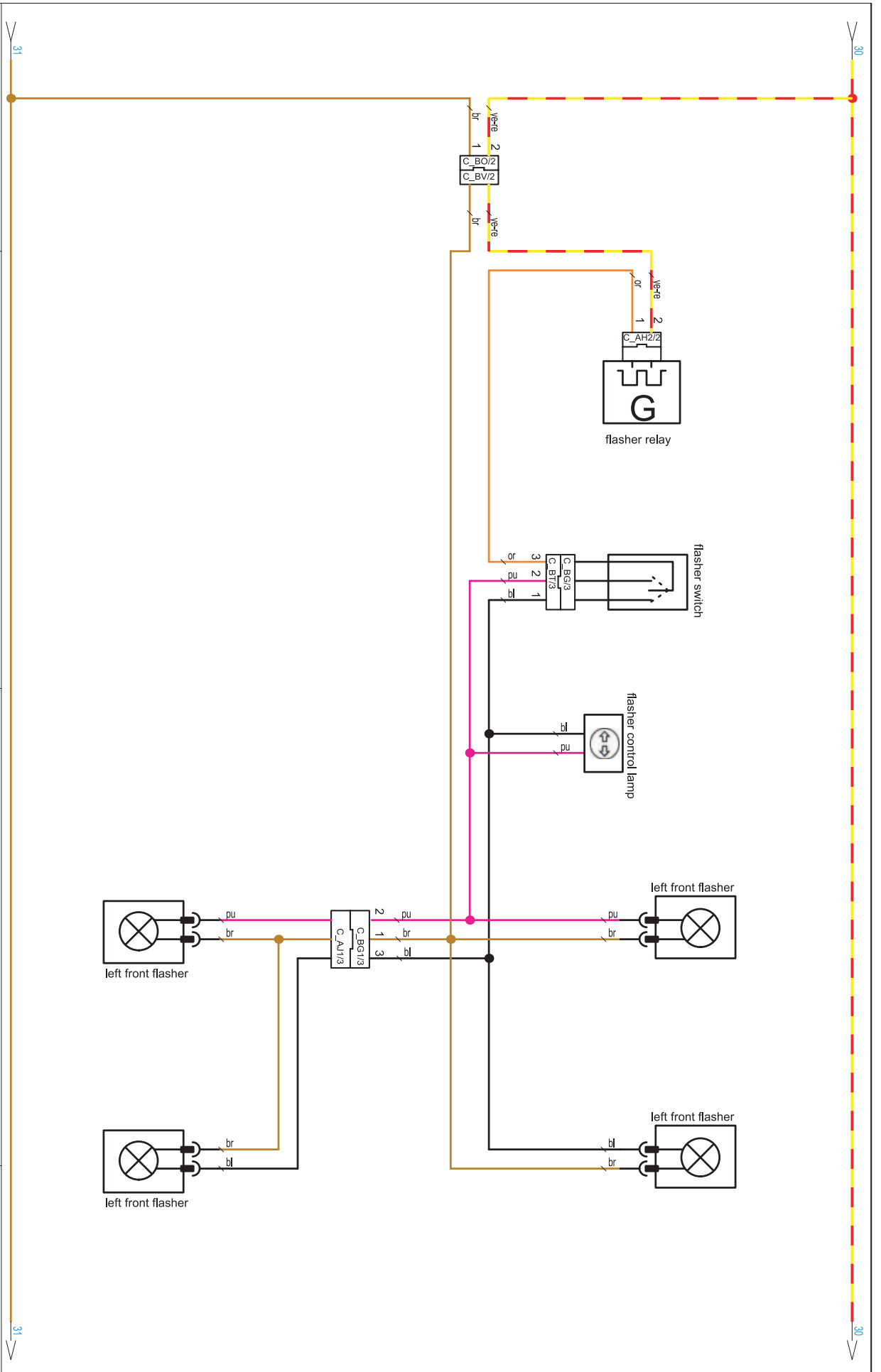



EXC 250-300 2005

positive connection

5/6

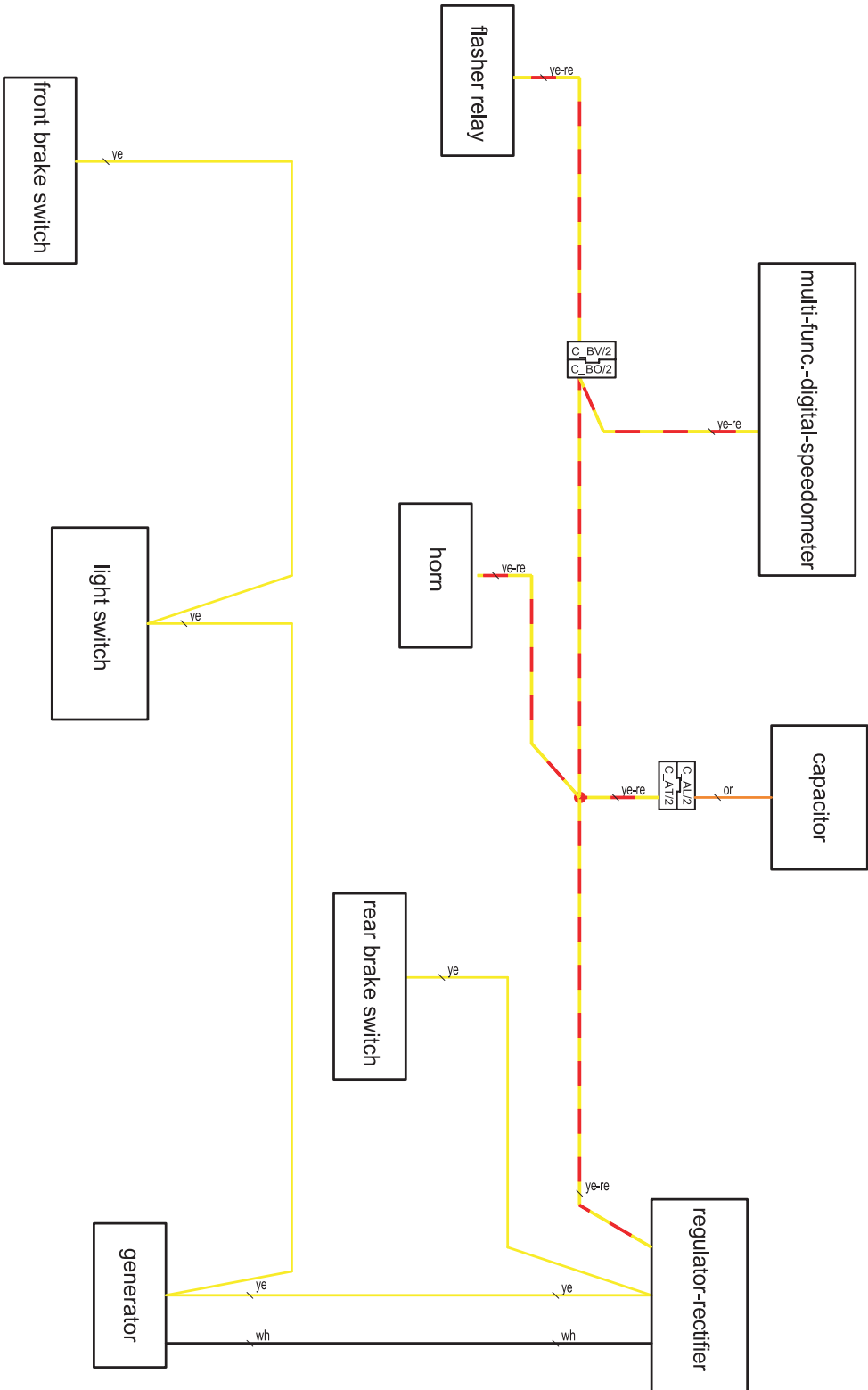

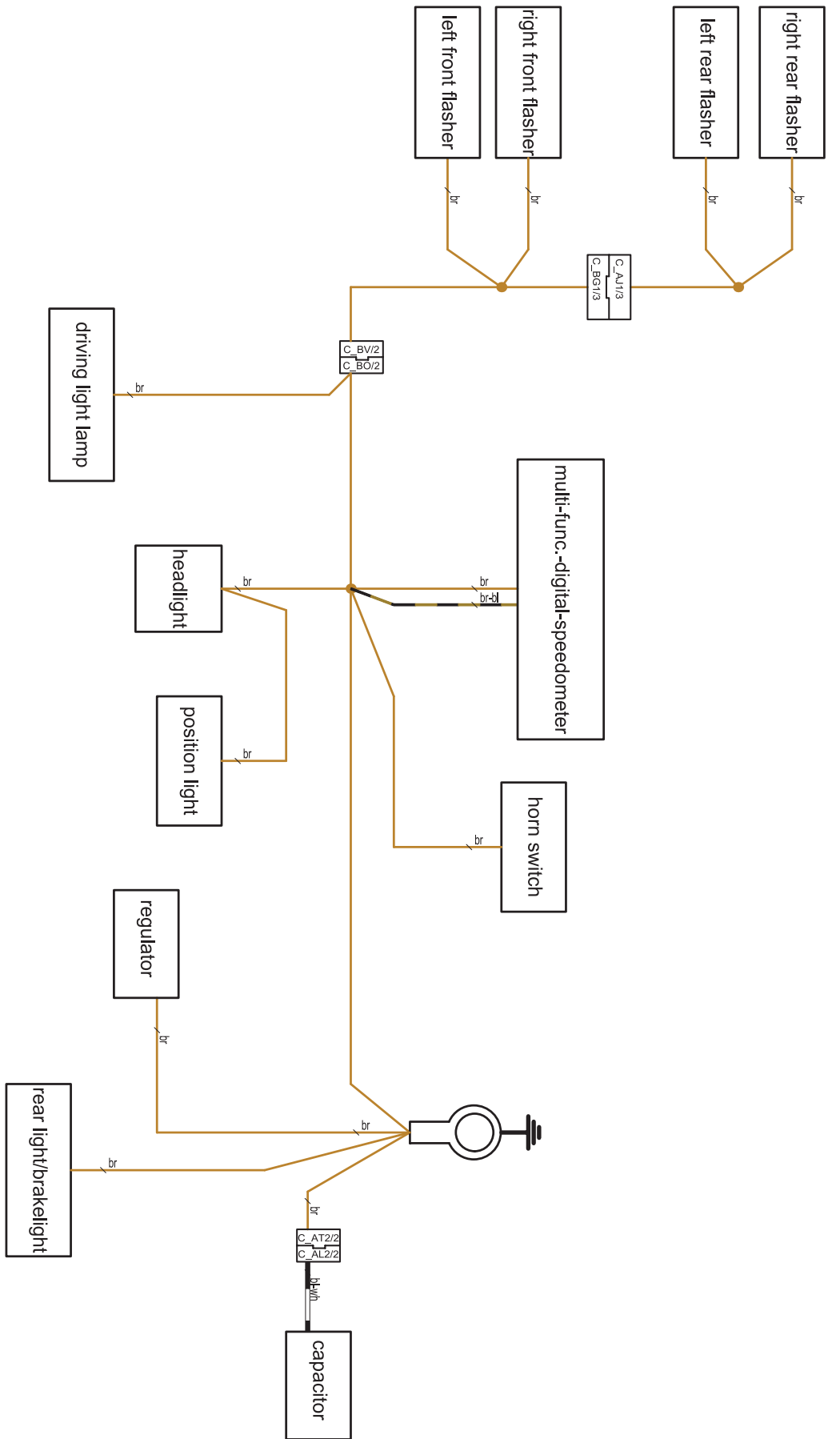





EXC 250-300 2005

ground connection

horn switch

cable color	re	br
HORN 	●	●
OFF		



light switch
high/low beam switch

cable color	bu	ye	gn	wh
LIGHT OFF				
P.LIGHT 		●	●	●
LO 		●	●	
HI 	●	●		
P.LIGHT 		●	●	●

brake switch

cable harness	gn-wh	ye
cable switch	bl	bl
pushed	●	●
unpushed		

flasher switch

cable harness	or	pu	bl
TURN L 	●	●	
TURN R 	●	●	●
OFF			

stop switch

cable harness	ye-bl	br
cable switch	ye-bl	br
pushed	●	●
unpushed		