Ambient Weather WS-2080 Wireless Home Weather Station User Manual



Table of Contents

1.	Introduction	3
2.	Warnings and Cautions	3
3.	Getting Started	3
3.1	Parts List.....	3
3.2	Recommend Tools.....	4
3.3	Sensor Assembly Set Up	4
3.4	Display Console	12
3.4.1	Display Console Layout.....	12
3.4.1	Initial Display Console Set Up.....	14
3.4.2	Radio Controlled Clock (RCC).....	14
3.4.3	Sensor Operation Verification	14
4.	Weather Station Installation	15
4.1	Pre Installation Checkout	15
4.2	Site Survey	15
4.3	Final Installation of Sensor Array.....	15
5.	Console Operation.....	15
5.1	Time	16
5.2	Date	17
5.3	Wind	18
5.4	Rain	19
5.5	Barometric Pressure	19
5.6	Pressure Graph	21
5.7	Weather Forecast (Tendency)	21
5.8	Indoor Temperature	22
5.9	Indoor Humidity	23
5.10	Outdoor Temperature, Wind Chill and Dew Point	24
5.11	Outdoor Humidity	24
5.12	Memory	25
6.	PC Software	25
6.1	EasyWeather Overview	25
6.2	Connect PC Connection	25
6.3	EasyWeather Software Installation.....	25
6.4	Run EasyWeather	26
6.5	EasyWeather Features	26
6.5.1	Main Display.....	26
6.5.2	Set-up and Alarms	27
6.5.3	Alarm Values	28
6.5.4	Historical Highs and Lows.....	29
6.5.5	Historical Data	30
6.5.6	Graph Data	31
6.5.7	Clearing Rainfall from EasyWeather.....	31
6.5.8	EasyWeather Legal Notes	32

7.	Glossary of Terms	32
8.	Specifications.....	33
8.1	Wireless Specifications	33
8.2	Measurement Specifications.....	33
8.3	Power Consumption	33
8.4	Cable Lengths.....	34
9.	Maintenance.....	34
10.	Troubleshooting Guide.....	34
11.	Accessories.....	36
12.	Liability Disclaimer.....	37
13.	FCC Statement.....	37
14.	Warranty Information	38

1. Introduction

Thank you for your purchase of the Ambient Weather WS-2080 wireless weather station. The following user guide provides step by step instructions for installation, operation and troubleshooting. To download the latest manual and additional troubleshooting tips, please visit:

<http://ambientweather.wikispaces.com/ws2080>

2. Warnings and Cautions

! **Warning:** Any metal object may attract a lightning strike, including your weather station mounting pole. Never install the weather station in a storm.

! **Warning:** Installing your weather station in a high location may result in injury or death. Perform as much of the initial check out and operation on the ground and inside a building or home. Only install the weather station on a clear, dry day.

3. Getting Started

The WS-2080 weather station consists of a display console (receiver), a thermo-hygrometer transmitter unit, a wind direction sensor, a wind speed sensor, a rain gauge, mounting hardware, USB cable and a PC software package on CD-ROM.

3.1 Parts List

QTY	Item
1	Display Console Frame Dimensions (LxWxH): 6.75" x 4.5" x 1.25" LCD Dimensions (LxW): 4.5" x 3.5"
1	Thermo-hygrometer transmitter
1	Thermo-hygrometer transmitter mounting bracket
1	Thermo-hygrometer transmitter rain shield
1	Wind direction sensor
1	Wind speed sensor
1	Anemometer mounting arm (L: 12")
1	Rain gauge
1	Rain gauge mounting bracket
1	USB cable (L: 41")
1	Easy Weather CD
3	1" nuts and bolts (long)
1	13/16" bolt (short)
1	1/2" set screw (long)
1	3/8" set screw (short) (Optional)
1	Upper pole (L: 12")
1	Lower pole (L: 12")

QTY	Item
4	Zip ties
2	Hose clamps (2 3/4" diameter)

3.2 Recommend Tools

- Precision screwdriver (for small Phillips screws)
- Pliers
- Phillips screwdriver
- Flat blade screwdriver
- Tack (small) hammer or rubber mallet
- Compass or GPS (for wind direction calibration)

3.3 Sensor Assembly Set Up

1. Connect the wind cup assembly to either end of the anemometer mounting arm. Align the holes, and fasten with long bolt and nut. Tighten with precision screwdriver while securing the nut with pliers, as shown in Figure 1.

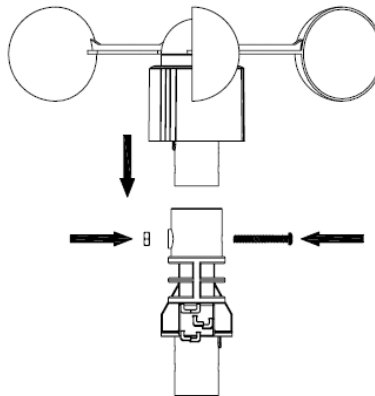

1

Figure 1

2. Connect the wind vane assembly to the other end of the anemometer mounting arm. Align the holes, and fasten with long bolt and nut. Tighten with precision screwdriver while securing the nut with pliers, as shown in Figure 2.

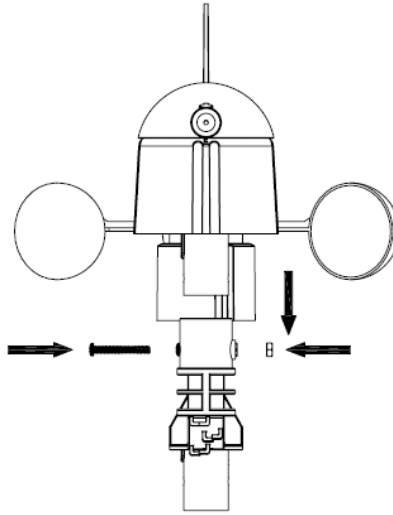

2

Figure 2

3. Connect the anemometer assembly to the top mounting pole, align the holes, and fasten with short set screw (optional, we recommend NOT connecting this) and long bolt and nut. Tighten with precision screwdriver while securing the nut with pliers, as shown in Figure 3.

 **Note:** This may be a tight fit – rotate the pole back and forth to shave off some of the plastic, and use a small hammer to tap the top of the anemometer mounting arm while securing the pole on a solid, flat surface. Use a piece of cloth or padding to dampen the hammer and avoid damage to the anemometer mounting arm.

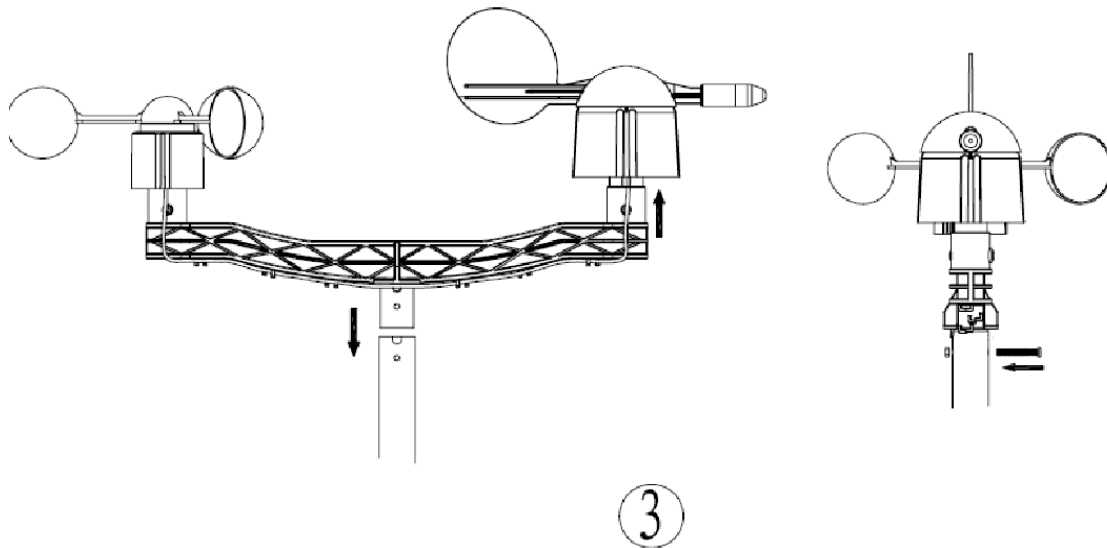

3
Figure 3

4. Connect the rain gauge with long set screw. Tighten with precision screwdriver, as shown in Figure 4.

 **Note:** There may be a slight “play” in the rain gauge and the screw may not be flush. Do not force the screw.

Attach the rain gauge mounting arm to the upper mounting pole, at right angles to the wind speed and wind direction assembly to avoid obstruction of rainfall.

 **Note:** There are two mounting holes on the side of the rain gauge in the event you wish to mount the rain gauge in a different location than the mounting arm.

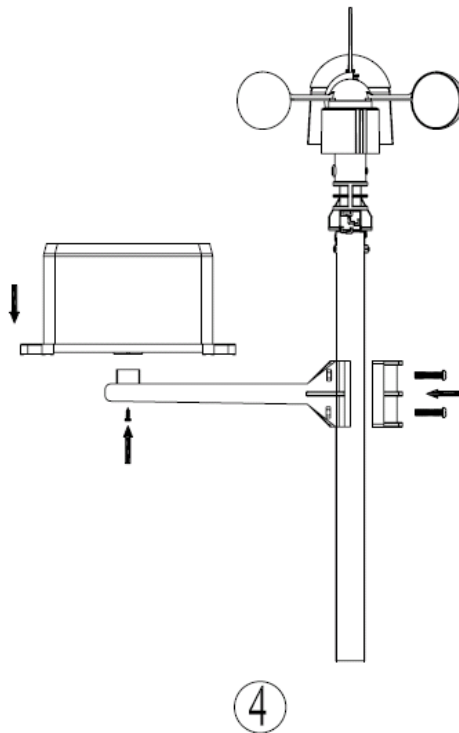

Figure 4

5. Connect the thermo-hygrometer with short bolt and nut. Tighten with precision screwdriver, as shown in Figure 5. Slide the rain shield over the thermo-hygrometer after connecting the cables from the anemometer and rain gauge (step 7). Attach to the thermo-hygrometer mounting arm to the upper mounting pole.

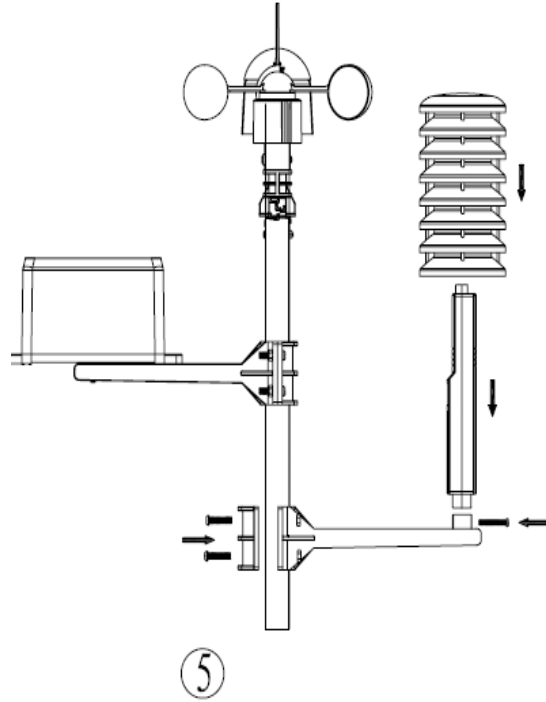

Figure 5

6. Fasten the lower mounting pole (which is swaged on the top end) to your mounting pole or bracket (purchased separately) with the hose clamps. Tighten the lower mounting pole to your mounting pole with the hose clamps with a flat head screw driver, as shown in Figure 6. Slide the top weather station pole (with the sensor array) into the lower pole (connected to your mounting pole) when your station is finally mounted.

When you install the weather station, you will need to calibrate the anemometer pointer to true north. True north can be estimated with a compass (which points to magnetic north) or a GPS, which provides true north. Wind direction is defined as the direction the wind is coming from (example, Winds from the north).

Note the four channels on the side of the wind vane. Each quadrant is labeled North, South, East and West (reference Figure 6 as an example for “E” or East). Locate the North direction (“N”) and mark it with a piece of tape for future reference. You will need this for wind direction calibration upon final assembly.

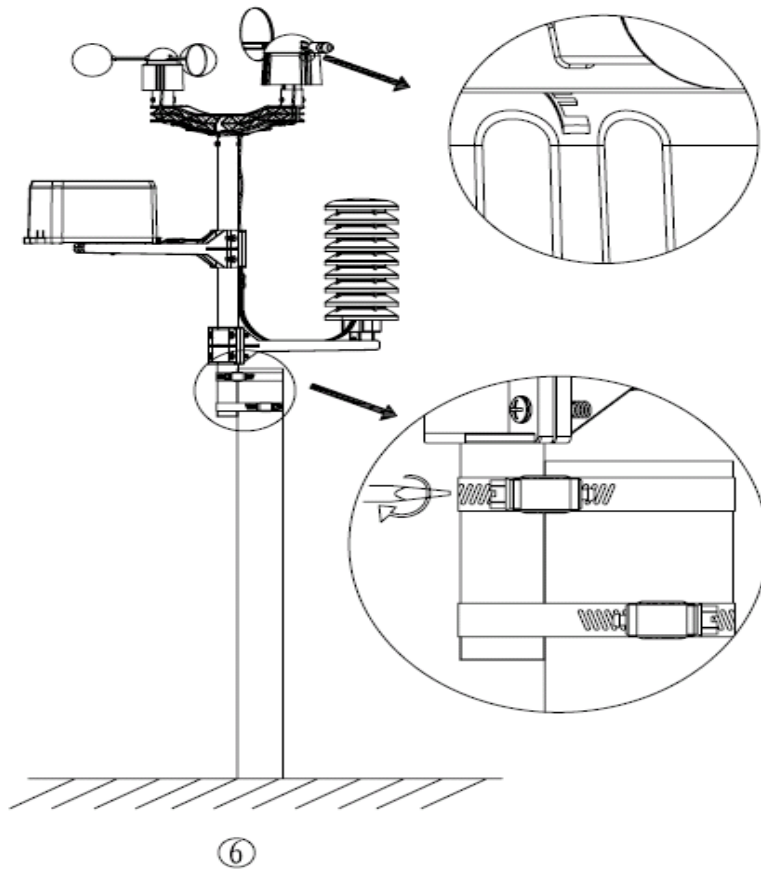

Figure 6

Connect the wind speed cable to the wind direction phone jack, as shown in Figure 7. Connect the wind direction cable to the thermo-hygrometer phone jack (reference the label on the thermo-hygrometer). Connect the rain gauge cable to the thermo-hygrometer phone jack (reference the label on the thermo-hygrometer).

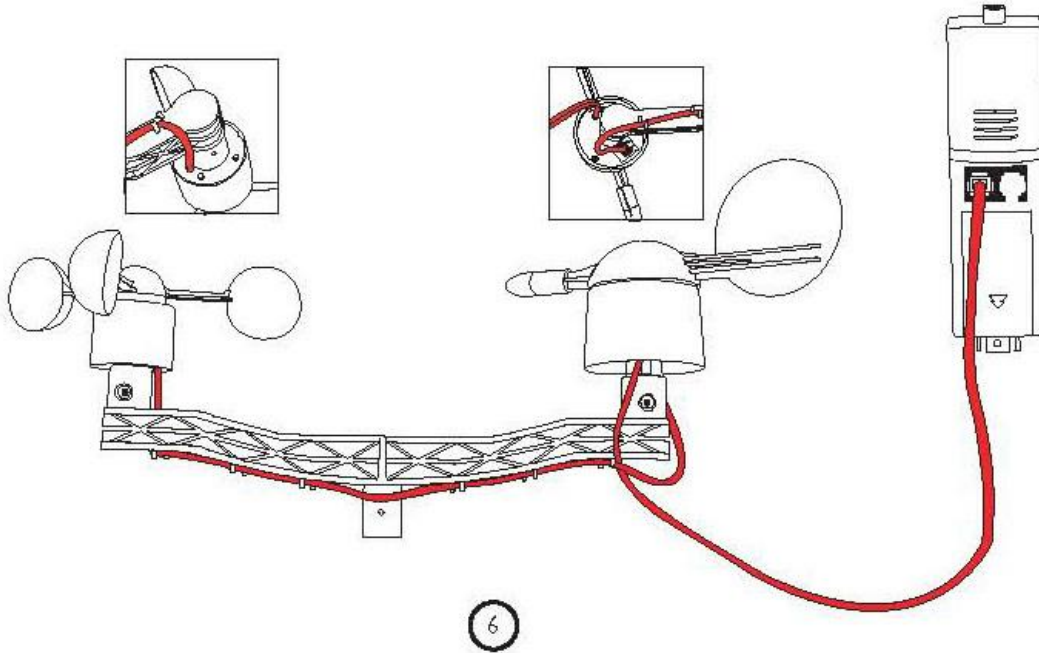



Figure 7

Insert two AA batteries in the thermo-hygrometer, as shown in Figure 8. The transmitter LED will light up momentarily (4 seconds), and then flash once every 48 seconds for each transmission update.

 **Note:** Do not install the batteries backwards. You can permanently damage the thermo-hygrometer. Do not use rechargeable batteries.

 **Note:** We recommend installing Lithium AA batteries:

<http://www.ambientweather.com/enaaliba4pa.html>

Lithium batteries provide longer life and operate in colder temperatures.

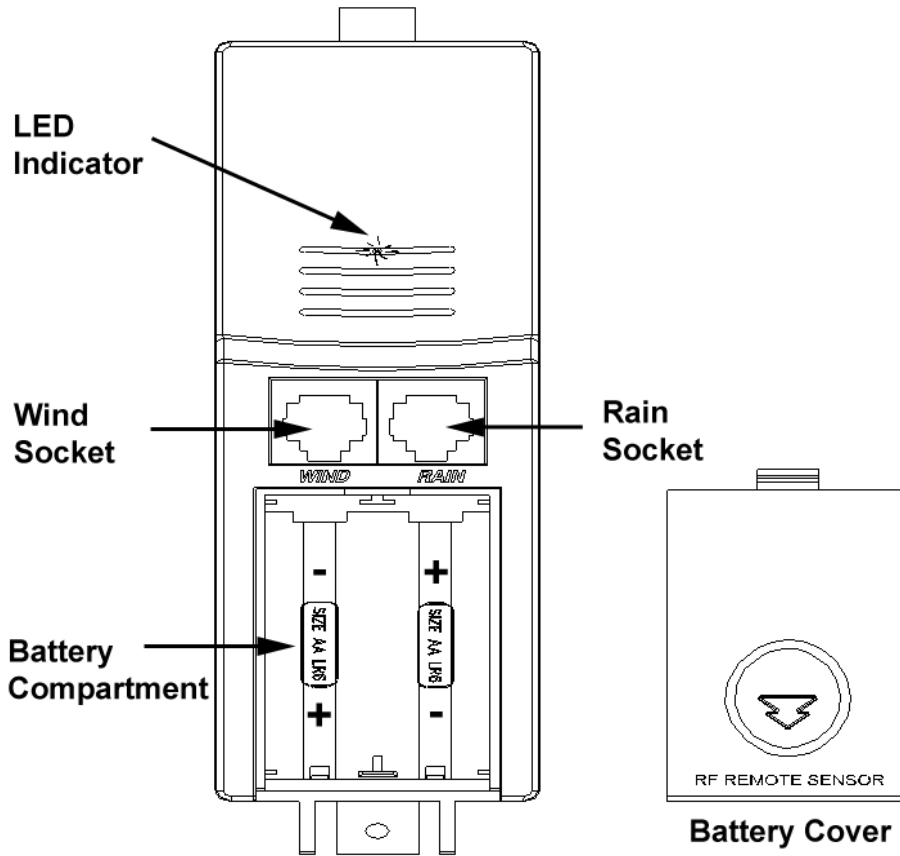

Figure 8

Install the rain shield over the thermo-hygrometer/transmitter, as shown in Figure 9, and use the enclosed zip ties to clean up the cables.

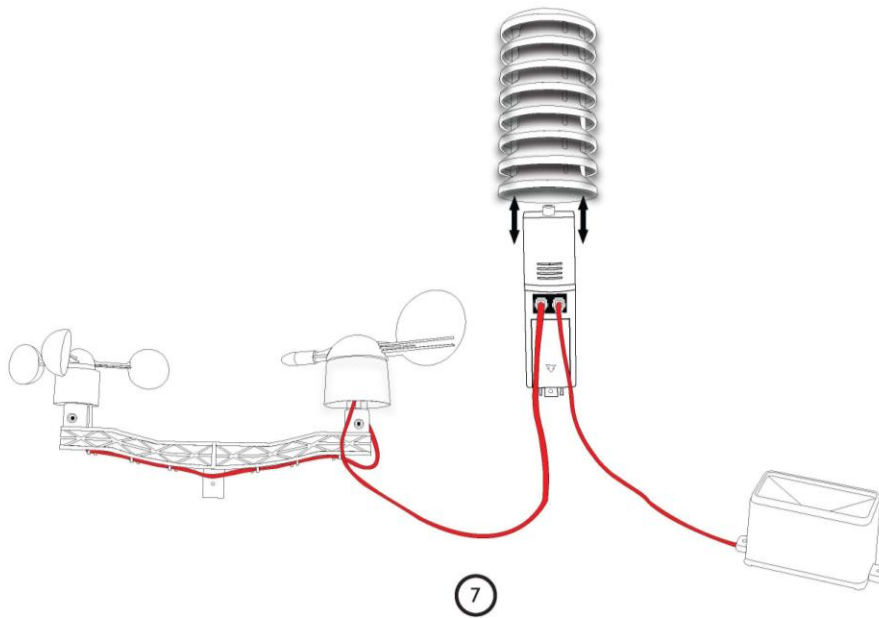

Figure 9

3.4 Display Console

3.4.1 Display Console Layout

The display console layout is shown in Figure 10.

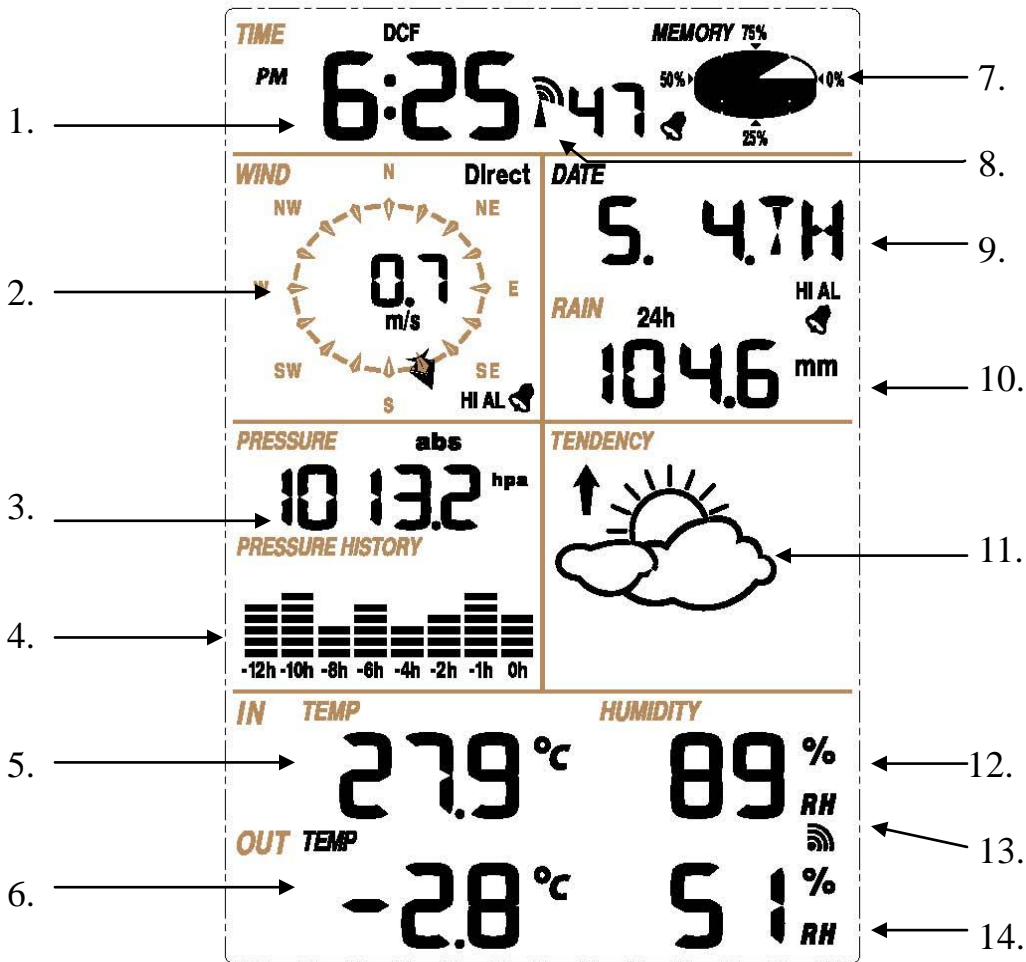



Figure 10

1. Time
2. Wind direction
3. Barometric Pressure
4. Barometric trend
5. Indoor Temperature
6. Outdoor Temperature
7. Memory
8. Radio Controlled Clock (RCC)
9. Date
10. Rainfall
11. Weather Forecast
12. Indoor Humidity
13. Outdoor reception signal
14. Outdoor Humidity

3.4.1 Initial Display Console Set Up

 **Note:** The sensor array must be powered and updating before powering up the console, or the console will timeout searching for the sensors. Perform this step last.

Make certain the weather station sensor array is at least 10' away from the console and within 300' of the console. If the weather station is too close or too far away, it will not receive a proper signal.

Insert two AA batteries into the battery compartment on the back of the display. After inserting the batteries into the console, all of the LCD segments will light up for a few seconds to verify all segments are operating properly.

The unit will instantly display indoor temperature, humidity, barometer, tendency, date and time. The wind speed, wind direction, rain, and outdoor temperature and humidity will update on the display within a few minutes. Do not Press any menu keys until the outside transmitter report in, otherwise the outdoor sensor search mode will be terminated. When the outdoor transmitter data has been received, the console will automatically switch to the normal mode from which all further settings can be performed.

If it does not update, please reference the troubleshooting guide in Section 9.

3.4.2 Radio Controlled Clock (RCC)

After the remote sensor is powered up, the sensor will transmit weather data for 30 seconds, and then the sensor will begin radio controlled clock (RCC) reception. During the RCC time reception period (maximum 10 minutes), no weather data will be transmitted to avoid interference.

If the signal reception is not successful within 1 minute, the signal search will be cancelled and will automatically resume every two hours until the signal is successfully captured. The regular RF link will resume once RCC reception routine is finished. In some locations, RCC reception may take a couple of days to receive the signal.

3.4.3 Sensor Operation Verification

The following steps verify proper operation of the sensors prior to installing the sensor array.

1. **Verify proper operation of the rain gauge.** Tip the sensor array back and forth several times. You should hear a “clicking” sound within the rain gauge. Verify the rain reading on the display console is not reading 0.00. Each “click” represents 0.01 inches of rainfall.
2. **Verify proper operation of the wind direction.** Align the wind vane pointer to North (as determined in Section 3.3). Verify the display reads North. Repeat for each quadrant (North, South, East, and West).
3. **Verify proper operating of the wind speed.** Rotate the wind cups manually or with a fan. Verify the wind speed is not reading 0.0.
4. **Verify proper operation of the indoor and outdoor temperature.** Verify the indoor and outdoor temperature match closely with the console and sensor array in the same location (about 10' apart). The sensors should be within 4°F (2°C) (the accuracy is ± 2°F / 1°C). Allow about 30 minutes for both sensors to stabilize.
5. **Verify proper operation of the indoor and outdoor humidity.** Verify the indoor and outdoor humidity match closely with the console and sensor array in the same location (about 10' apart). The sensors should be within 8% (the accuracy is ± 4%). Allow about 30 minutes

for both sensors to stabilize.

4. Weather Station Installation

4.1 Pre Installation Checkout

Before installing your weather station in the permanent location, we recommend operating the weather station for one week in a temporary location with easy access. This will allow you to check out all of the functions, insure proper operation, and familiarize you with the weather station and calibration procedures. This will also allow you to test the wireless range of the weather station.

4.2 Site Survey

Perform a site survey before installing the weather station. Consider the following:

1. You must clean the rain gauge once per year and change the batteries every two years. Provide easy access to the weather station.
2. Avoid radiant heat transfer from buildings and structures. In general, install the sensor array at least 5' from any building, structure, ground, or roof top.
3. Avoid wind and rain obstructions. The rule of thumb is to install the sensor array at least four times the distance of the height of the tallest obstruction. For example, if the building is 20' tall, install 4 x 20' = 80' away. Use common sense. If the weather station is installed next to a tall building, the wind and rain will not be accurate.
4. Wireless Range. The radio communication between receiver and transmitter in an open field can reach a distance of up to 330 feet, providing there are no interfering obstacles such as buildings, trees, vehicles, high voltage lines. Wireless signals will not penetrate metal buildings.
5. Radio interference such as PCs, radios or TV sets can, in the worst case, entirely cut off radio communication. Please take this into consideration when choosing console or mounting locations.
6. Visit Ambient Weather Mounting Solutions for assistance and ideas for mounting your weather station:

<http://www.ambientweather.com/amwemoso.html>

4.3 Final Installation of Sensor Array

Mount the weather station in the permanent location. To calibrate the wind direction, align the wind direction pointer with the "N" marking on the side of the wind direction sensor, as described in Section 3.3. Rotate the upper pole until the vane pointer, marking, and true north wind direction are aligned.

5. Console Operation

 **Note:** You can also program the weather station console through the PC software (recommended).

 **Note:** The display console has six keys for basic operation: **menu** key, **up** key, **down** key, **enter** key, **history** key, and **on/off** key.

To enter the Set mode, press the **menu** key. The Set mode can be exited at any time by either pressing the **history** key or waiting for the 30-second time-out to take effect. You can skip over any

setting by pressing the **menu** key again.

Holding the **up** or **down** key when in the Set mode will increase/decrease values rapidly.

5.1 Time

Press the **menu** key to enter the TIME Set Mode. You can skip over any setting by selecting the **enter** key.



Figure 11

1. **Display Contrast Level.** The display contrast value will begin flashing (example, lcd0 thru lcd8).

Press the **up** key or **down** key to adjust the contrast level from 0 to 8 (the default is 5).

2. **Time Zone.** Press the **enter** key to display the time zone. The time zone value will begin flashing.

Press the **up** key or **down** key to adjust the time zone from -12 to 12, based on the number of hours from Coordinated Universal Time, or Greenwich Mean Time (GMT).

The following table provides times zones throughout the world. Locations in the eastern hemisphere are positive, and locations in the western hemisphere are negative.

Hours from GMT	Time Zone	Cities
-12	IDLW: International Date Line West	---
-11	NT: Nome	Nome, AK
-10	AHST: Alaska-Hawaii Standard CAT: Central Alaska HST: Hawaii Standard	Honolulu, HI
-9	YST: Yukon Standard	Yukon Territory
-8	PST: Pacific Standard	Los Angeles, CA, USA
-7	MST: Mountain Standard	Denver, CO, USA
-6	CST: Central Standard	Chicago, IL, USA
-5	EST: Eastern Standard	New York, NY, USA
-4	AST: Atlantic Standard	Caracas
-3	---	São Paulo, Brazil
-2	AT: Azores	Azores, Cape Verde Islands
-1	WAT: West Africa	---
0	GMT: Greenwich Mean WET: Western European	London, England
1	CET: Central European	Paris, France
2	EET: Eastern European	Athens, Greece
3	BT: Baghdad	Moscow, Russia
4	---	Abu Dhabi, UAE
5	---	Tashkent
6	---	Astana
7	---	Bangkok

Hours from GMT	Time Zone	Cities
8	CCT: China Coast	Beijing
9	JST: Japan Standard	Tokyo
10	GST: Guam Standard	Sydney
11	---	Magadan
12	IDLE: International Date Line East NZST: New Zealand Standard	Wellington, New Zealand

- 12/24 Hour Format.** Press the **enter** key to change the 12/24 hour format. Press the **up** key or **down** key to alternate the display unit between 12 hour format and 24 hour format.
- Daylight Saving Time.** Press the **enter** key to turn ON and OFF daylight savings time (DST) observance (example, Arizona and parts of Indiana do not observe daylight savings time). Press the **on/off** key to alternate the display unit between ON and OFF.
- Change Hour.** Press the **enter** key to set the hour. Press the **up** key or **down** key to change the hour setting. Manually setting the time overrides the automatic RCC time.
- Change Minute.** Press the **enter** key to set the minute. Press the **up** key or **down** key to change the minute setting. Manually setting the time overrides the automatic RCC time.

5.2 Date

Press the **menu** key to enter the Date Set Mode. You can skip over any setting by selecting the **enter** key.



Figure 12

- Alarm Time, Date and Date of the Week.** The date will be flashing.
Press the **up** key or **down** key to alternate the display between the alarm time, and date and week date.
- Date Format** Press the **enter** key to display the date format (Md for month/day or Dm for Day/Month). The date value will begin flashing.
Press the **up** key or **down** key to adjust the alternate the display between the DD-MM format and MM-DD format for the date.
- Change Year.** Press the **enter** key to set the year. The year will begin flashing. Press the **up** key or **down** key to change the year setting.
- Change Month.** Press the **enter** key to set the month. The month will begin flashing. Press the **up** key or **down** key to change the month setting.
- Change Day.** Press the **enter** key to set the day. The day will begin flashing. Press the **up** key or **down** key to change the day setting.

6. **Change Alarm Hour.** Press the **enter** key to set the alarm hour. The alarm hour and ALARM will begin flashing. Press the **up** key or **down** key to change the alarm hour setting.
7. **Change Alarm Minute.** Press the **enter** key to set the alarm minute. The alarm minute will begin flashing. Press the **up** key or **down** key to change the alarm minute setting.

Press the **ON/OFF** key to select the alarm on or off (if the alarm is enabled, the alarm icon  will be turned on in the Time section).

5.3 Wind

Press the **menu** key to enter the Wind Set Mode. You can skip over any setting by selecting the **enter** key.

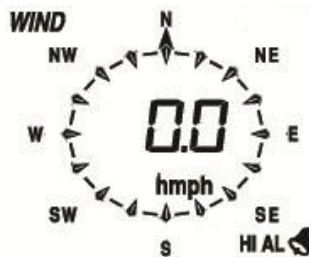

Figure 13

1. **Average Wind Speed and Wind Gust.** Press the **up** key or **down** key to alternate the display between the 48 second Wind Speed Average and Gust Speed (or the maximum wind speed in the update period).

2. **Wind Speed Units.** Press the **enter** key to set the wind speed units. The wind speed units will begin flashing.

Press the **up** key or **down** key to alternate the display unit between km/h, mph, m/s, knots, and bft (or Beaufort scale).

3. **Wind Speed High Alarm.** Press the **enter** key to set the wind speed high alarm setting. The wind speed high alarm and HI AL (high alarm) will begin flashing.

Press the **up** key or **down** key to adjust the high wind speed alarm.

Press the **ON/OFF** key to select the alarm on or off (if the alarm is enabled, the alarm icon  will be turned on).

4. **Wind Direction Alarm.** Press the **enter** key to set the wind direction alarm setting. The wind direction alarm and Direct (wind direction) will begin flashing.

Press the **up** key or **down** key to adjust the wind direction alarm.

Press the **ON/OFF** key to select the alarm on or off (if the alarm is enabled, the alarm icon  will be turned on).

5. **Wind Speed Record High.** Press the **enter** key to display maximum wind speed record since the last reset. The maximum record will be flashing, and the **MAX** icon will light up (in the tendency section). To reset, press the **enter** key for 3 seconds, and the maximum value (and associated date and time) will be reset to current reading.

5.4 Rain

Press the **menu** key to enter the Rain Set Mode. You can skip over any setting by selecting the **enter** key.



Figure 14

1. **Rain Increment.** Press the **up** key or **down** key to alternate the display between 1 hour, 24 hour, week, month and total rain increments.
2. **Rain Units.** Press the **enter** key to set the rain units. The rain units will begin flashing.

Press the **up** key or **down** key to alternate the display unit between inches and mm.

Rain High Alarm. Press the **enter** key to set the rain high alarm function. The rain high alarm and HI AL (high alarm) will begin flashing.

Press the **up** key or **down** key to adjust the rain alarm.

Press the **ON/OFF** key to select the alarm on or off (if the alarm is enabled, the alarm icon  will be turned on).

3. **Rain Record High.** Press the **enter** key to display maximum rain record since the last reset. The maximum record will be flashing, and the **MAX** icon will light up (in the tendency section). To reset, press the **enter** key for 3 seconds, and the maximum value (and associated date and time) will be reset to current reading.
4. **Reset Rain.** Press the **enter** key to reset the rain values. The rain and CLEAR will begin flashing. To reset, press **enter** key for 3 seconds and the 1 hour, 24 hour, week, month and total rain will reset to 0.

5.5 Barometric Pressure

 **Note:** The weather station console displays two different pressures: absolute (measured) and relative (corrected to sea-level).

To compare pressure conditions from one location to another, meteorologists correct pressure to sea-level conditions. Because the air pressure decreases as you rise in altitude, the sea-level corrected pressure (the pressure your location would be at if located at sea-level) is generally higher than your measured pressure.

Thus, your absolute pressure may read 28.62 inHg (969 mb) at an altitude of 1000 feet (305 m), but the relative pressure is 30.00 inHg (1016 mb).

The standard sea-level pressure is 29.92 in Hg (1013 mb). This is the average sea-level pressure around the world. Relative pressure measurements greater than 29.92 inHg (1013 mb) are considered high pressure and relative pressure measurements less than 29.92 inHg are considered low pressure.

To determine the relative pressure for your location, locate an official reporting station near you (the internet is best source for real time barometer conditions, such as Weather.com or Wunderground.com), and set your weather station to match the official reporting station.

Press the **menu** key to enter the Pressure Mode. You can skip over any setting by selecting the **enter** key.



Figure 15

1. **Relative vs. Absolute Pressure Display.** Press the **up** key or **down** key to alternate the display between relative (rel) pressure and absolute (abs) pressure.

2. **Pressure Units.** Press the **enter** key to set the pressure units. The pressure units will begin flashing.

Press the **up** key or **down** key to alternate the display unit between hPa, inHg and mmHg.

3. **Relative Pressure Calibration.** When Absolute (abs) pressure is selected, this step will be skipped.

Press the **enter** key to set the relative pressure calibration. The relative pressure will flash.

Press the **up** key or **down** key to change the value.

4. **Pressure High Alarm.** Press the **enter** key to set the pressure high alarm function. Pressure and **HI AL** (high alarm) icon will flash.

Press the **up** key or **down** key to change the value.

Press the **ON/OFF** key to select the alarm on or off (if the alarm is enabled, the alarm icon  will be turned on).

5. **Pressure Low Alarm.** Press the **enter** key to set the pressure low alarm function. Pressure and **LO AL** (high alarm) icon will flash.

Press the **up** key or **down** key to change the value.

Press the **ON/OFF** key to select the alarm on or off (if the alarm is enabled, the alarm icon  will be turned on).

6. **Pressure Record High.** Press the **enter** key to display maximum pressure record since the last reset. The maximum record will be flashing, and the **MAX** icon will light up (in the tendency section). To reset, press the **enter** key for 3 seconds, and the maximum value (and associated date and time) (and associated date and time) will be reset to current reading.
7. **Pressure Record Low.** Press the **enter** key to display minimum pressure record since the last reset. The minimum record will be flashing, and the **MIN** icon will light up (in the tendency section). To reset, press the **enter** key for 3 seconds, and the minimum value (and associated date and time) will be reset to current reading.

5.6 Pressure Graph

 **Note:** The weather station bar graph flashes from left to right to prevent screen burn in. This feature cannot be turned off.

Press the **enter** key to set the pressure graph history time axis. The pressure graph time axis will begin flashing.

Press the **up** key or **down** key to change the pressure history time axis between 12 hours and 24 hours.

5.7 Weather Forecast (Tendency)

 **Note:** The weather forecast or pressure tendency is based in the rate of change of barometric pressure. In general, when the pressure increases, the weather improves (sunny to partly cloudy) and when the pressure decreases, the weather degrades (cloudy to rain).

The weather forecast is an estimation or generalization of weather changes in the next 24 to 48 hours, and varies from location to location. The tendency is simply a tool for projecting weather conditions and is never to be relied upon as an accurate method to predict the weather.

Press the **menu** key to enter the TENDANCY Set Mode. You can skip over any setting by selecting the **enter** key.

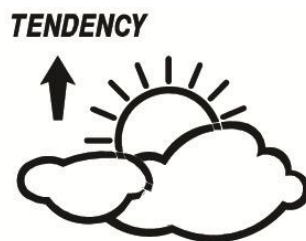

Figure 16

1. **Change Tendency.** Press the **up** key or **down** key to alternate the display between SUNNY, PARTLY CLOUDY and CLOUDY, and RAINY.
2. **Pressure Threshold.** Press the **enter** key to change the pressure threshold. The up and down arrow and pressure tendency will be flashing. Press the **up** key or **down** key to adjust the pressure threshold from 2.0 to 4.0 hPa/hr (the default is 2 hPa/hr).
3. **Storm Threshold.** Press the **enter** key to change the storm threshold. The up and down arrow and pressure tendency will be flashing. Press the **up** key or **down** key to adjust the pressure threshold from 3.0 to 9.0 hPa/hr (the default is 4 hPa/hr).

5.8 Indoor Temperature

Press the **menu** key to enter the INDOOR TEMPERATURE Set Mode. You can skip over any setting by selecting the **enter** key.

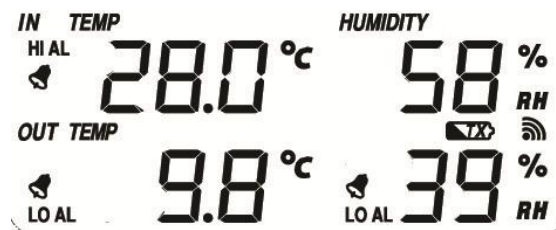



Figure 17

1. **Indoor Temperature Units.** Press the **up** key or **down** key to alternate the display unit between °C and °F.
2. **Indoor Temperature High Alarm.** Press the **enter** key to set the indoor temperature high alarm function. The indoor temperature and **HI AL** (high alarm) will begin flashing.

Press the **up** key or **down** key to change the value.

Press the **ON/OFF** key to select the alarm on or off (if the alarm is enabled, the alarm icon  will be turned on).

3. **Indoor Temperature Low Alarm.** Press the **enter** key to set the indoor temperature low alarm function. The indoor temperature and **LO AL** (high alarm) will begin flashing.
- 4.

Press the **up** key or **down** key to change the value.

Press the **ON/OFF** key to select the alarm on or off (if the alarm is enabled, the alarm icon  will be turned on).

5. **Indoor Temperature Record High.** Press the **enter** key to display maximum indoor temperature record since the last reset. The maximum temperature record and **MAX** icon (in

the tendency section) will begin flashing. To reset, press the **enter** key for 3 seconds, and the maximum value (and associated date and time) (and associated date and time) will be reset to current reading.

6. **Indoor Temperature Record Low.** Press the **enter** key to display minimum indoor temperature record since the last reset. The minimum temperature record and **MIN** icon (in the tendency section) will begin flashing. To reset, press the **enter** key for 3 seconds, and the minimum value (and associated date and time) will be reset to current reading.

5.9 Indoor Humidity

Press the **menu** key to enter the INDOOR HUMIDITY Set Mode. You can skip over any setting by selecting the **enter** key.

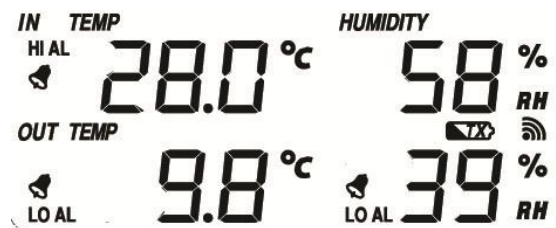



Figure 18

1. **Indoor Humidity High Alarm.** Press the **enter** key to set the indoor humidity high alarm function. The indoor humidity and **HI AL** (high alarm) will begin flashing.

Press the **up** key or **down** key to change the value.

Press the **ON/OFF** key to select the alarm on or off (if the alarm is enabled, the alarm icon  will be turned on).

2. **Indoor Humidity Low Alarm.** Press the **enter** key to set the indoor humidity low alarm function. The indoor humidity and **LO AL** (high alarm) will begin flashing.

3. Press the **up** key or **down** key to change the value.

Press the **ON/OFF** key to select the alarm on or off (if the alarm is enabled, the alarm icon  will be turned on).

4. **Indoor Humidity Record High.** Press the **enter** key to display maximum indoor humidity record since the last reset. The maximum humidity record and **MAX** icon (in the tendency section) will begin flashing. To reset, press the **enter** key for 3 seconds, and the maximum value (and associated date and time) (and associated date and time) will be reset to current reading.

5. **Indoor Humidity Record Low.** Press the **enter** key to display minimum indoor humidity record since the last reset. The minimum humidity record and **MIN** icon (in the tendency section) will begin flashing. To reset, press the **enter** key for 3 seconds, and the minimum value (and associated date and time) will be reset to current reading.

5.10 Outdoor Temperature, Wind Chill and Dew Point

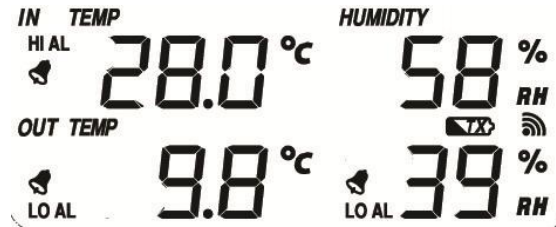



Figure 19

1. **Outdoor Temperature, Wind chill and Dew Point.** Press the **up** key or **down** key to alternate the display between the outdoor temperature, wind chill and dew point.
2. **Outdoor Temperature Units.** Press the **up** key or **down** key to alternate the display unit between °C and °F.
3. **Outdoor Temperature High Alarm.** Press the **enter** key to set the outdoor temperature high alarm function. The outdoor temperature and **HI AL** (high alarm) will begin flashing.

Press the **up** key or **down** key to change the value.

Press the **ON/OFF** key to select the alarm on or off (if the alarm is enabled, the alarm icon  will be turned on).

4. **Outdoor Temperature Low Alarm.** Press the **enter** key to set the outdoor temperature low alarm function. The outdoor temperature and **LO AL** (high alarm) will begin flashing.

5. Press the **up** key or **down** key to change the value.

Press the **ON/OFF** key to select the alarm on or off (if the alarm is enabled, the alarm icon  will be turned on).

6. **Outdoor Temperature Record High.** Press the **enter** key to display maximum outdoor temperature record since the last reset. The maximum temperature record and **MAX** icon (in the tendency section) will begin flashing. To reset, press the **enter** key for 3 seconds, and the maximum value (and associated date and time) (and associated date and time) will be reset to current reading.

7. **Outdoor Temperature Record Low.** Press the **enter** key to display minimum outdoor temperature record since the last reset. The minimum temperature record and **MIN** icon (in the tendency section) will begin flashing. To reset, press the **enter** key for 3 seconds, and the minimum value (and associated date and time) will be reset to current reading.

8. Repeat the above steps for wind chill and dew point.

5.11 Outdoor Humidity

Please reference Section Indoor Humidity. The outdoor procedure is similar to the indoor humidity procedure.

5.12 Memory

The console stores up to 4080 complete sets of weather data with associated time and date stamp. The base station will lose all of the weather data if there a power interruption. In the event the memory is full, the old data is overwritten by the new data.

Press the **history** key to review the historical data.

1. Select the **down** key to review historical data archived in the console. Select the **up** key to advance historical data archived in the console (default is 30 minute intervals).

When history data displayed, the corresponding date and time will be displayed at the time section area.

The historical archive interval can only be changed using the PC software that comes with this product. The factory default archive interval is 30 minutes.

2. **Clear Memory.** Press the **history** key to clear memory. The memory fill icon will be flashing. Press and hold **enter** key for 3 seconds to clear memory.

6. PC Software

 **Note:** EasyWeather software is included with this weather station package. Easy Weather runs on most PC operating systems. Cumulus is free internet publishing PC software application by Sandaysoft. WeatherSnoop is a paid software and internet publishing application for Macs by Tee-Boy.

For EasyWeather updates and alternate PC applications, visit:

<http://ambientweather.wikispaces.com/ws2080>

6.1 EasyWeather Overview

EasyWeather allows you to display real-time data, program the display console, set alarms, view and export historical data and create graphs. Whereas the weather station console is limited to 4080 records, EasyWeather is only limited by your PC's memory.

6.2 Connect PC Connection

Connect the weather station console to the PC using the included USB cable. The computer should acknowledge the connection with a beep and the device installation notice will be displayed if connected for the first time.

6.3 EasyWeather Software Installation

Insert the included CD into your hard drive and the software installer will automatically start. If it does not, browse to My Computer (or Computer) in windows and locate the CD Drive. Right click on this drive, select **Explore** and run **Setup.exe**.

The software will install to the program files directory.

6.4 Run EasyWeather

To run EasyWeather, in Windows, select Start -> **All Programs** -> **Easy Weather**.

 **Note:** You may be prompted to run EasyWeather as the administrator (Vista and Windows7). To perform this action, browse to the program files directory location using Windows explorer, commonly located here:

C:\Program Files\EasyWeather

Right Click on the **EasyWeather.exe** icon, select the **Compatibility** Tab and under **Privilege Level**, select **Run as Administrator**.

Failure to run the program as administrator may limit the graphical display mode capability, since EasyWeather writes data to file locations deemed protected with strict Microsoft protection enabled.

 **Note:** If you run the program for the first time, the current weather will be displayed and at the bottom line of the window, and the program will show related information regarding reading historical data into the PC.

When there is large amount of archived data to be uploaded, it may take a few minutes before the system will respond to your requests. Otherwise, it will display the “read weather data fail” error message, since the USB port is reading the data from the memory and the system is not able to respond to requests.

6.5 EasyWeather Features

The following section outlines the features available in the EasyWeather Software.

6.5.1 Main Display

When you launch HeavyWeather, the main display will be shown. The main display shows current weather conditions, alarm settings and minimum and maximum data.

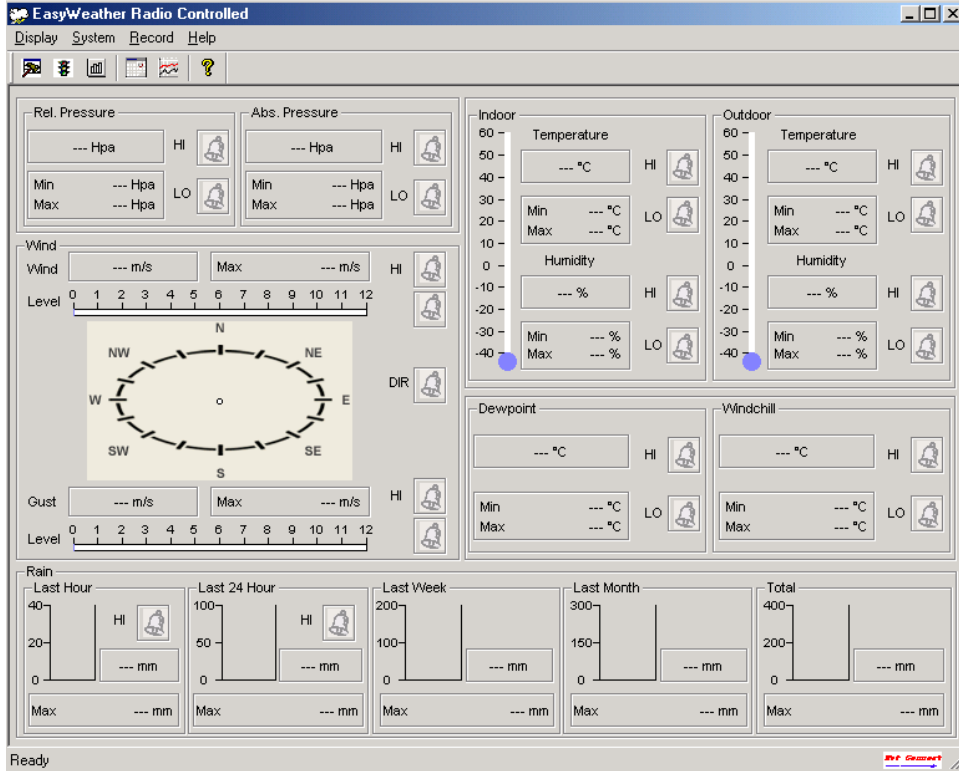





Figure 20

When console is connected to PC, the connected icon  will be displayed on the main display panel. If the console is not connected, the not connected icon  will be displayed.

6.5.2 Set-up and Alarms

Select **System | Setup** from the menu bar to program general weather station console settings and turn on and off alarm conditions, or select the  icon.

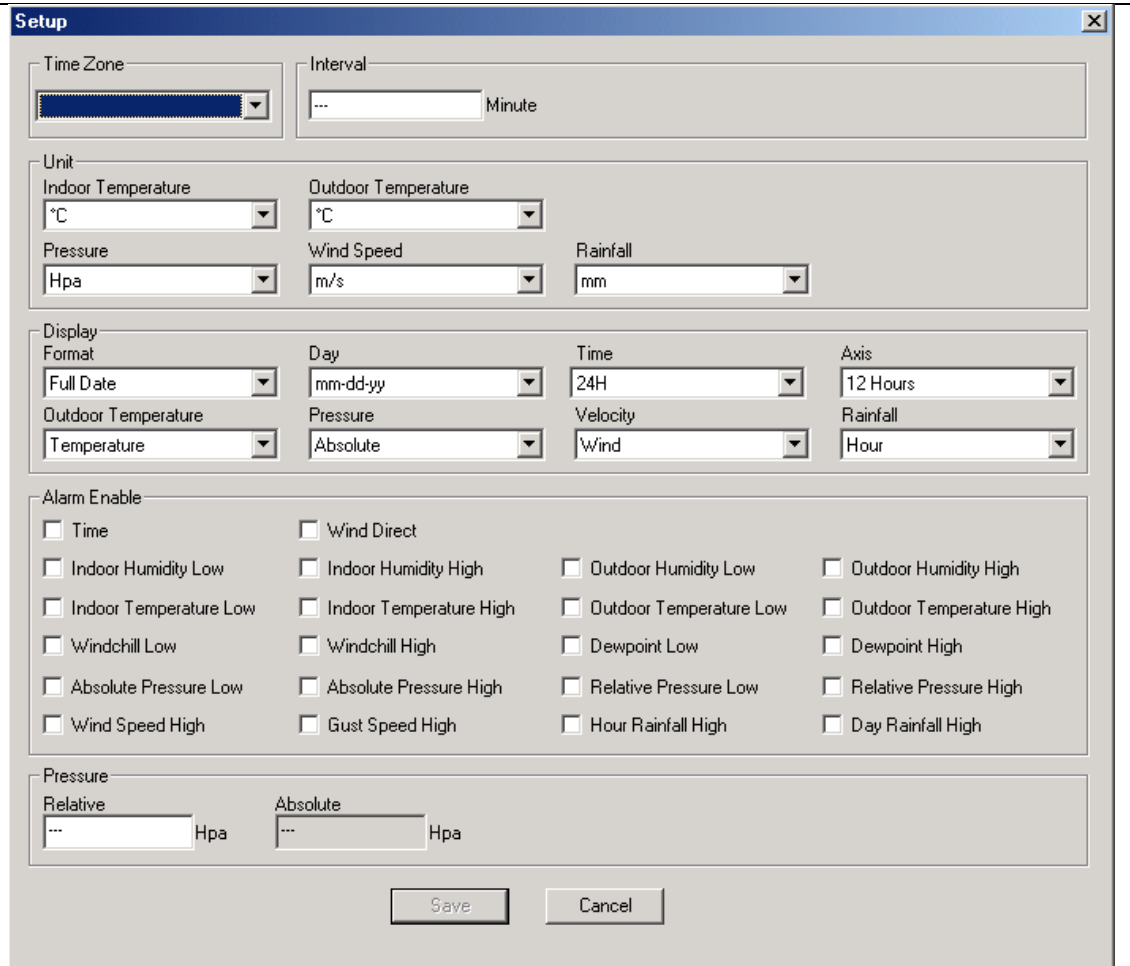



Figure 21

6.5.3 Alarm Values

Select **System | Alarm** from the menu bar to program general to set the alarm ranges, or select the  icon.

Alarm ✕

Time	
Hour 07	Minute 30
Indoor Humidity	
High 70 %	Low 60 %
Outdoor Humidity	
High 80 %	Low 30 %
Indoor Temperature	
High 35.0 °C	Low 0.0 °C
Outdoor Temperature	
High 45.0 °C	Low 0.0 °C
Windchill	
High -30.0 °C	Low -30.0 °C
Dewpoint	
High -30.0 °C	Low -30.0 °C
Absolute Pressure	
High 29.80 inHg	Low 29.20 inHg
Relative Pressure	
High 30.10 inHg	Low 29.20 inHg
Wind	
High 20.0 km/h	4 bft
Gust	
High 40.0 km/h	6 bft
Rain	
High Hour 1.0 mm	High 24 Hour 1.0 mm
Wind Direct N	
<input type="button" value="Save"/> <input type="button" value="Cancel"/>	

Figure 22

6.5.4 Historical Highs and Lows

Select **System | Scope** from the menu bar to view the historical highs and lows, or select the  icon.

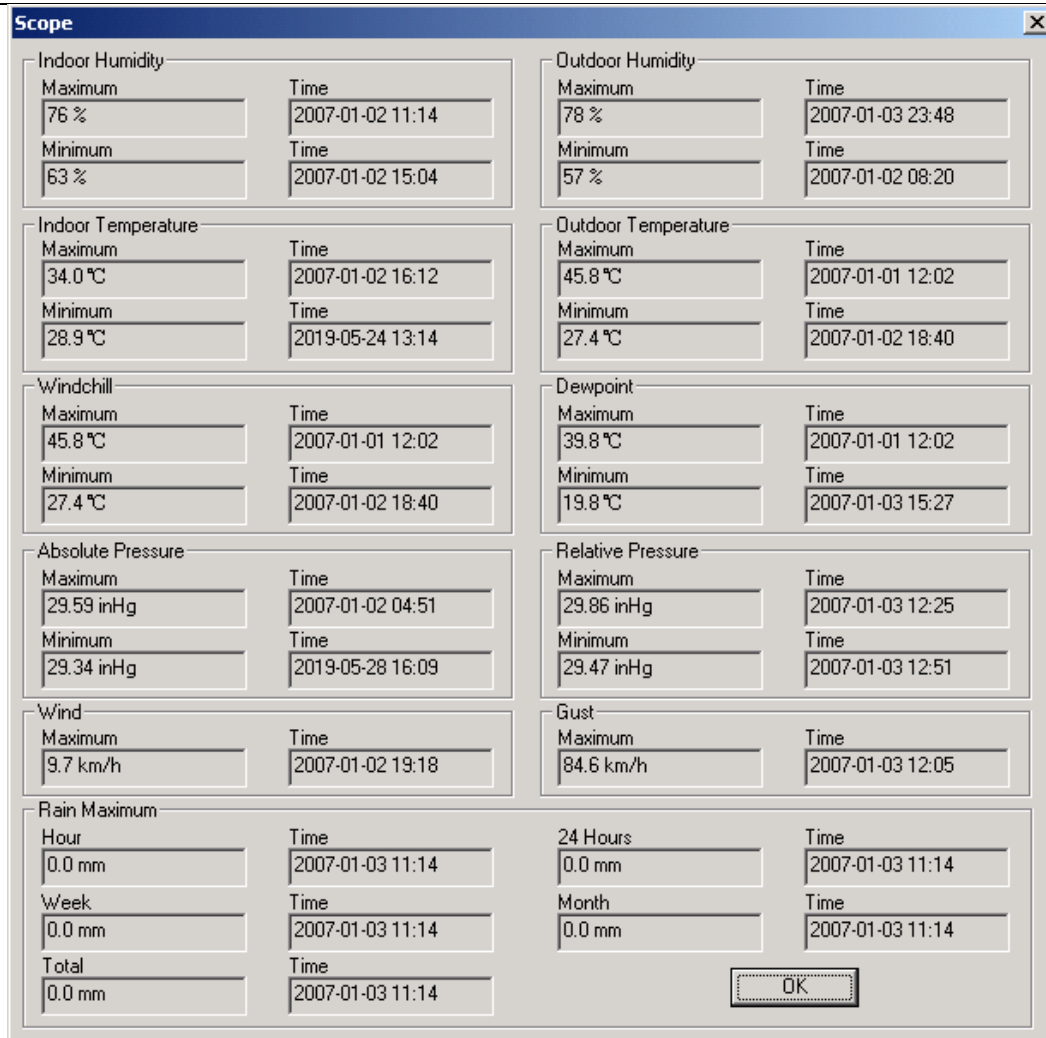

Figure 23

6.5.5 Historical Data

Select **Record | History** from the menu bar to view the historical data, or select the



icon.

This window displays the recorded history data in a spread sheet format. If you want to see all history data in a specified time period, enter the time duration and press **Search** to reload the historical data.

You can export the selected historical data into a text format file by selecting the **Export** button.

When memory on the console is full, select the **Clear Memory** button to clear memory on the console (remember to upload all of the data before pressing this button).

If you want to start a new weather history record, select the **Clear Data** button to clear the database, and all historical weather data will be deleted (if you would like to keep a back up history file before

deleting all weather data, you can make a copy of the “EasyWeather.dat” file into another folder or just rename the “EasyWeather.dat” file, such as “Jan-07.dat”, for future reference.

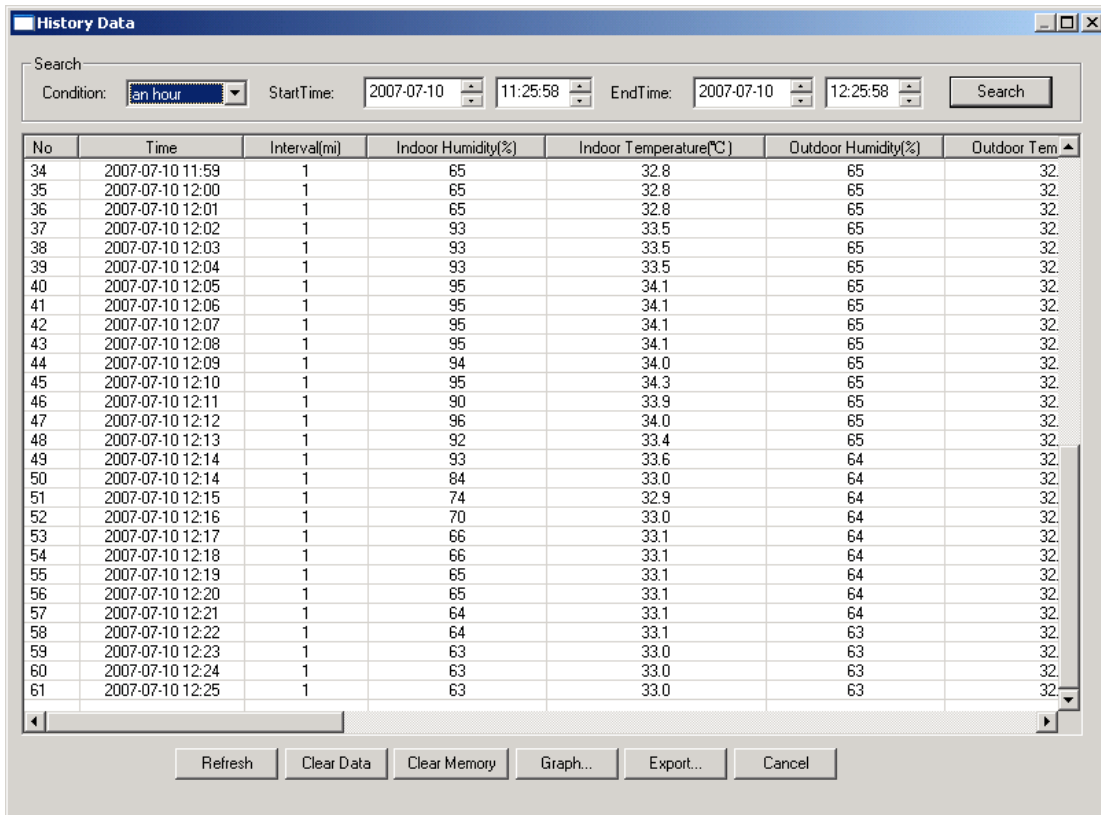



Figure 24

6.5.6 Graph Data

Select **Record | Graph** from the menu bar to view the graphical data, or select the  icon.

6.5.7 Clearing Rainfall from EasyWeather

To clear rainfall from EasyWeather, select **Record | History** from the menu bar and select **Clear Data** to clear all rainfall totals.



Figure 25

6.5.8 EasyWeather Legal Notes

- We reserve the right to delete or change any image whether or not purposely uploaded onto the server by a user of the EasyWeather software products.
- The EasyWeather software products are protected by copyright laws and international copyright treaties as well as other intellectual property laws and treaties.
- You may not copy the printed materials accompanying the products.

7. Glossary of Terms

Term	Definition
Absolute Barometric Pressure	Relative barometric pressure, corrected to sea-level. To compare pressure conditions from one location to another, meteorologists correct pressure to sea-level conditions. Because the air pressure decreases as you rise in altitude, the sea-level corrected pressure (the pressure your location would be at if located at sea-level) is generally higher than your measured pressure.
Accuracy	Accuracy is defined as the ability of a measurement to match the actual value of the quantity being measured.
HectoPascals (hPa)	Pressure units in SI (international system) units of measurement. Same as millibars (1 hPa = 1 mbar)
Hygrometer	A hygrometer is a device that measures relative humidity. Relative humidity is a term used to describe the amount or percentage of water vapor that exists in air.
Inches of Mercury (inHg)	Pressure in Imperial units of measure.

	1 inch of mercury = 33.86 millibars
Radio Controlled Clock (RCC)	The United States government distributes time-of-day to the public using radio broadcasts. The low frequency (LF) station WWVB is located in Fort Collins, Colorado and broadcasts on 60 kHz. The high frequency (HF) stations WWV and WWVH are located in Colorado and Hawaii respectively, and broadcast on five different frequencies ranging from 2.5 to 20 MHz. At least one HF signal should always be usable at any given time anywhere in the United States.
Range	Range is defined as the amount or extent a value can be measured.
Relative Barometric Pressure	Measured barometric pressure relative to your location or ambient conditions.
Resolution	Resolution is defined as the number of significant digits (decimal places) to which a value is being reliably measured.
Wind Vane	A wind vane is a device that measures the direction of the wind. The wind vane is usually combined with the anemometer. Wind direction is the direction from which the wind is blowing.

8. Specifications

8.1 Wireless Specifications

- Line of sight wireless transmission (in open air): 300 feet
- Update Rate: 48 seconds
- Frequency: 433 MHz

8.2 Measurement Specifications

The following table provides the specifications for the measured parameters.

Measurement	Range	Accuracy	Resolution
Indoor Temperature	32 to 140 °F	± 2 °F	0.1 °F
Outdoor Temperature	-40 to 149 °F	± 2 °F	0.1 °F
Indoor Humidity	10 to 99%	± 5%	1 %
Outdoor Humidity	10 to 99%	± 5%	1 %
Barometric Pressure	8.85 to 32.50 inHg	± 0.08 inHg (within range of 27.13 to 32.50 inHg)	0.01 inHg
Rain	0 to 394 in.	± 10%	0.01 in
Wind Direction	0 - 360 °	22.5° (16 point compass)	22.5° (16 point compass)
Wind Speed	0 to 112 mph	± 2.2 mph or 10% (whichever is greater)	0.1 mph

8.3 Power Consumption

- Base station : 3XAA 1.5V LR6 Alkaline batteries
- Remote sensor : 2xAA 1.5V LR6 Alkaline batteries
- Battery life: Minimum 12 months for base station
Minimum 24 months for thermo-hygro sensor (use lithium batteries in cold weather climates)

8.4 Cable Lengths

- Anemometer to Thermo-Hygrometer-Transmitter: 8.5 feet
- Rain Gauge to Thermo-Hygrometer-Transmitter: 8.5 feet

9. Maintenance

1. Clean the rain gauge once every 3 months
2. Replace the thermo-hygrometer transmitter batteries once every 1-2 years
3. Clean the wind vane and thermo-hygrometer transmitter connectors with rubbing alcohol and q-tip once every 1-2 years.

10. Troubleshooting Guide

If your question is not answered here, you can contact us as follows:









1. Email Support: support@ambientweather.com
2. Live Chat Support: www.ambientweather.com/chat.html (M-F 8am to 4pm Arizona Time)
3. Technical Support: 480-283-1644 (M-F 8am to 4pm Arizona Time)



Problem	Solution
<p>Wireless remote (thermo-hygrometer) not reporting in to console.</p> <p>There are dashes on the display console.</p>	<p>The maximum line of sight communication range is 300'. Move the sensor assembly closer to the display console.</p> <p>If the sensor assembly is too close (less than 10'), move the sensor assembly away from the display console.</p> <p>Cycle power on the console. The console may have exited the search mode.</p> <p>Install a fresh set of batteries in the remote thermo-hygrometer. For cold weather environments, install lithium batteries.</p> <p>Make sure the remote sensors are not transmitting through solid metal (acts as an RF shield), or earth barrier (down a hill).</p> <p>Move the display console around electrical noise generating devices, such as computers, TVs and other wireless transmitters or receivers.</p> <p>Move the remote sensor to a higher location.</p> <p>Radio Frequency (RF) Sensors cannot transmit through metal barriers (example, aluminum siding) or multiple, thick walls.</p>
<p>Temperature sensor reads too high in the day time.</p>	<p>In hot weather climates, the rain guard and solar shield may not be effective enough. Consider the following</p>

Problem	Solution
	radiation shield: http://www.ambientweather.com/amwesrpatcan.html
Indoor and Outdoor Temperature do not agree	Allow up to one hour for the sensors to stabilize due to signal filtering. The indoor and outdoor temperature sensors should agree within 4 °F (the sensor accuracy is ± 2 °F)
Indoor and Outdoor Humidity do not agree	Allow up to one hour for the sensors to stabilize due to signal filtering. The indoor and outdoor humidity sensors should agree within 10 % (the sensor accuracy is ± 5 %)
Humidity reads – instead of a value.	If the humidity falls outside the measurement range (10 to 99%), the humidity will display “—“
Absolute pressure does not agree with official reporting station	<p>You may be viewing the relative pressure, not the absolute pressure.</p> <p>Select the absolute pressure. Make sure you properly calibrate the sensor to an official local weather station. Reference Section Barometric Pressure5.5 for details.</p> <p>The barometer is only accurate to ± 0.08 inHg within the following relative pressure range: 27.13 to 32.50 inHg, which corresponds to an altitude of -2,200 to 2,700 feet. At higher altitudes, expect some non-linearity or error.</p>
Rain gauge reports rain when it is not raining	An unstable mounting solution (sway in the mounting pole) may result in the tipping bucket incorrectly incrementing rainfall. Make sure you have a stable mounting solution. Move the rain gauge from the pole mount to a flat, stable mount (fixed, flat structure).
Software does not recognize weather station	Make sure the USB cable is plugged in and recognized by the PC operating system. If it is not recognized, try a different USB connection. Avoid USB hubs.
Barometer graph flashes. Can I turn this off?	No, this feature prevents burn in of the display monitor.
Wind speed appears low	Average wind speed may have the appearance of low wind. Try switching the display to wind gust.
Display console is difficult to read	<p>Change the display contrast level as described in Section 5.1.</p> <p>Replace the batteries in the console with a fresh set of batteries.</p>
Can the lamp be turned on all of time?	No, to prevent the bulb from burning out, it can only turn on temporarily.
The forecast icon is not accurate	<p>The weather station console must run for several days to trend barometric pressure.</p> <p>The weather forecast is an estimation or generalization of weather changes in the next 24 to 48 hours, and varies from location to location. The tendency is simply a tool for projecting weather conditions and is never to be relied upon as an accurate method to predict the weather.</p>

11. Accessories

The following software and hardware accessories are available for this weather station at www.AmbientWeather.com.

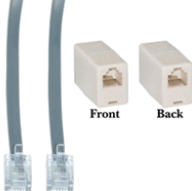
Accessory	Image	Description
Ambient Weather BCY29 4 in 1 Pocket Precision Screwdriver		This precision screwdriver kit is a must for assembling this weather station due to the small, precision screws.
Weather Station Mounting Solutions		Pole mounting solutions, tripods, mast to mast mounting kits. The WS-1080 pole mount can be attached to a pole mounting solution with the included hose clamps.
Ambient Weather D4 Universal Weather Station Console Desk Stand		Universal desk stand allows the display console to stand upright.
Cumulus Software by Sandaysoft www.sandaysoft.com		Free internet publishing software allows you to publish to the internet real time. Supports www.WeatherUnderground.com and CWOP/APRS. Choose the Fine Offset weather station option.
WeatherSnoop Weather Underground Publishing Mac Software 		WeatherSnoop connects your weather station to your Mac to the WeatherUnderground with a simple, easy to use interface. WeatherSnoop stores all of your weather data locally in a compact SQLite database. This data can then be used by other applications for detailed analysis and trending.
Weather Exchange		Free internet client software receives data posted by www.WeatherUnderground.com and allows you to view your weather station data real time, along with thousands of other weather stations. Includes forecasts, radar and alarms.
Kestrel Instruments Silva Polaris Handheld Compass for Anemometer Calibration		Handheld compass for wind direction calibration.
Energizer AA Lithium Battery (2-pack) - Batteries for Long Life and Cold Climates		AA lithium batteries for cold weather climates.

Accessory	Image	Description
Ambient Weather SRS100LX Temperature and Humidity Solar Radiation Shield		Solar Radiation Shield improves temperature accuracy for hot weather climates. Remove the rain guard and install over thermo-hygrometer.
Cable Extensions		Cable extension kits allow you to extend the cables between the anemometer and rain gauge to the thermo-hygrometer, improving the flexibility of the installation.
WeatherHub2 AMBNSLU2 Universal IP Ethernet Server		The WeatherHub2 is a data logger and IP Ethernet Weather Station Server in one. Simply plug the WeatherHub2 data logger into the back of your console and connect the cable to your cable/DSL router. Within minutes, you'll be able to see your weather data live on the Internet. Allows you to turn off your PC. Perfect for remote monitoring.

12. Liability Disclaimer

Please help in the preservation of the environment and return used batteries to an authorized depot. The electrical and electronic wastes contain hazardous substances. Disposal of electronic waste in wild country and/or in unauthorized grounds strongly damages the environment.

Reading the “User manual” is highly recommended. The manufacturer and supplier cannot accept any responsibility for any incorrect readings and any consequences that occur should an inaccurate reading take place.

This product is designed for use in the home only as indication of weather conditions. This product is not to be used for medical purposes or for public information.

The specifications of this product may change without prior notice.

This product is not a toy. Keep out of the reach of children.

No part of this manual may be reproduced without written authorization of the manufacturer.

Ambient, LLC WILL NOT ASSUME LIABILITY FOR INCIDENTAL, CONSEQUENTIAL, PUNITIVE, OR OTHER SIMILAR DAMAGES ASSOCIATED WITH THE OPERATION OR MALFUNCTION OF THIS PRODUCT. THIS PRODUCT.

13. FCC Statement

Statement according to FCC part 15.19:

This device complies with part 15 of the FCC rules. Operation is subject to the following two conditions:

1. This device may not cause harmful interference.

2. This device must accept any interference received, including interference that may cause undesired operation.

Statement according to FCC part 15.21:

Modifications not expressly approved by this company could void the user's authority to operate the equipment.

Statement according to FCC part 15.105:

NOTE: This equipment has been tested and found to comply with the limits for a Class B digital device, pursuant to Part 15 of the FCC Rules. These limits are designed to provide reasonable protection against harmful interference in a residential installation. This equipment generates, uses and can radiate radio frequency energy and, if not installed and used in accordance with the instructions, may cause harmful interference to radio communications.

However, there is no guarantee that interference will not occur in a particular installation. If this equipment does cause harmful interference to radio or television reception, which can be determined by turning the equipment off and on, the user is encouraged to try to correct the interference by one or more of the following measures:

- Reorient or relocate the receiving antenna.
- Increase the separation between the equipment and receiver.
- Connect the equipment into an outlet on a circuit different from that to which the receiver is connected.
- Consult the dealer or an experienced radio/TV technician for help.

14. Warranty Information

Ambient, LLC provides a 1-year limited warranty on this product against manufacturing defects in materials and workmanship.

This limited warranty begins on the original date of purchase, is valid only on products purchased and only to the original purchaser of this product. To receive warranty service, the purchaser must contact Ambient, LLC for problem determination and service procedures.

Warranty service can only be performed by a Ambient, LLC. The original dated bill of sale must be presented upon request as proof of purchase to Ambient, LLC.

Your Ambient, LLC warranty covers all defects in material and workmanship with the following specified exceptions: (1) damage caused by accident, unreasonable use or neglect (lack of reasonable and necessary maintenance); (3) damage resulting from failure to follow instructions contained in your owner's manual; (4) damage resulting from the performance of repairs or alterations by someone other than an authorized Ambient, LLC authorized service center; (5) units used for other than home use (6) applications and uses that this product was not intended (7) the products inability to receive a signal due to any source of interference or metal obstructions and (8) extreme acts of nature, such as lightning strikes or floods.

This warranty covers only actual defects within the product itself, and does not cover the cost of installation or removal from a fixed installation, normal set-up or adjustments, claims based on misrepresentation by the seller or performance variations resulting from installation-related circumstances.



