



This is a digital copy of a book that was preserved for generations on library shelves before it was carefully scanned by Google as part of a project to make the world's books discoverable online.

It has survived long enough for the copyright to expire and the book to enter the public domain. A public domain book is one that was never subject to copyright or whose legal copyright term has expired. Whether a book is in the public domain may vary country to country. Public domain books are our gateways to the past, representing a wealth of history, culture and knowledge that's often difficult to discover.

Marks, notations and other marginalia present in the original volume will appear in this file - a reminder of this book's long journey from the publisher to a library and finally to you.

Usage guidelines

Google is proud to partner with libraries to digitize public domain materials and make them widely accessible. Public domain books belong to the public and we are merely their custodians. Nevertheless, this work is expensive, so in order to keep providing this resource, we have taken steps to prevent abuse by commercial parties, including placing technical restrictions on automated querying.

We also ask that you:

- + *Make non-commercial use of the files* We designed Google Book Search for use by individuals, and we request that you use these files for personal, non-commercial purposes.
- + *Refrain from automated querying* Do not send automated queries of any sort to Google's system: If you are conducting research on machine translation, optical character recognition or other areas where access to a large amount of text is helpful, please contact us. We encourage the use of public domain materials for these purposes and may be able to help.
- + *Maintain attribution* The Google "watermark" you see on each file is essential for informing people about this project and helping them find additional materials through Google Book Search. Please do not remove it.
- + *Keep it legal* Whatever your use, remember that you are responsible for ensuring that what you are doing is legal. Do not assume that just because we believe a book is in the public domain for users in the United States, that the work is also in the public domain for users in other countries. Whether a book is still in copyright varies from country to country, and we can't offer guidance on whether any specific use of any specific book is allowed. Please do not assume that a book's appearance in Google Book Search means it can be used in any manner anywhere in the world. Copyright infringement liability can be quite severe.

About Google Book Search

Google's mission is to organize the world's information and to make it universally accessible and useful. Google Book Search helps readers discover the world's books while helping authors and publishers reach new audiences. You can search through the full text of this book on the web at <http://books.google.com/>

The Edison alkaline storage battery

Edison Storage
Battery Company



PROPERTY OF
*University of
Michigan
Libraries*
1817

ARTES SCIENTIA VERITAS

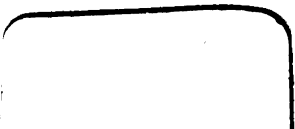

309

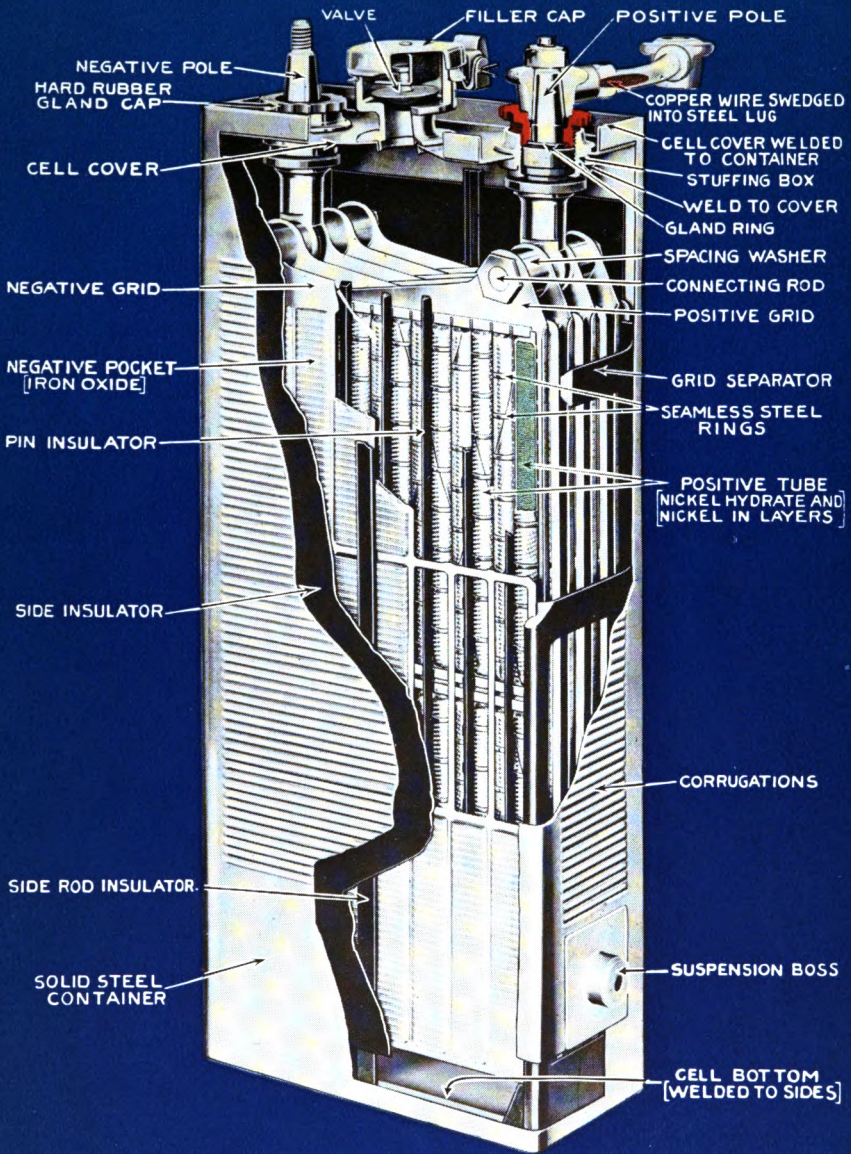

Edison Alkaline Storage Battery
 Being constructed of steel, it is the
 strongest and longest lived battery made.

NATIONAL EDUCATION ASSOCIATION
JOINT-COMMITTEE SERIES
MONOGRAPH III

THE EDISON ALKALINE STORAGE BATTERY

*By The Technical Staff Of The
Edison Storage Battery Company*



ORANGE, N. J.
EDISON STORAGE BATTERY COMPANY
1924

Printed in U. S. A.

Engin. Library

630
1.5
1916

COPYRIGHT 1916
EDISON STORAGE BATTERY COMPANY

SB 804-5M-5M

Publishers.
9+
1-3-1925

ENGIN. LIB.
QC
6.35
1524
1924

Argument

IN ACCEPTING THE INVITATION of the Joint Committee on Physics to prepare a Monograph, we welcome the opportunity to co-operate with educators in teaching boys and girls to meet conditions as they exist in the business world.

The familiarity in his school days with practical commercial apparatus will give the young graduate a great advantage over those who have received their laboratory instruction only with the aid of so-called "educational" apparatus. In no other professional or technical course (chemistry, metallurgy, medicine, etc.) does laboratory apparatus differ materially from that which the student must use in his actual life work. Yet the physics or electrical student has been handicapped by the fact that he practically never handles, and, in many cases, never even sees, commercial devices, until he takes his first position. The movement started by the Joint Committee on Physics deserves, therefore, the hearty co-operation of the manufacturers who will shortly employ the students now going through school. However, the *success* of the movement will depend solely on its adoption by the educators themselves.

This pamphlet has been prepared to facilitate the making of education in storage battery operation more practical. The storage battery industry will be entered by the student of today at what may be termed a critical period. The past few years have seen a remarkable advance in the application of storage batteries to all kinds of mechanical traction, railway train lighting, the lighting of country homes, yacht and motor-boat lighting, railway, fire alarm and police signaling, submarine boats, miners' safety lamps, wireless operation, and innumerable other services. Taking the electric truck and delivery wagon alone, available records from a large city show a gain of 400 per cent in only two years. The storage battery is thus entering practically every field of engineering and industry, and the importance of adequate instruction is evident. If this book can help the teacher towards this end our object will have been attained.

The limitations of a book of this kind make it impossible to describe in great detail all of the applications of Edison Storage Batteries in vehicle, marine, lighting, mining,

and the many other services where it has been successfully employed. For those interested in such information, we have prepared special bulletins, which we will gladly send on request. We are also always glad to take up, by special correspondence, discussions of unusual or specific applications.

Teachers and their pupils are always welcome to visit our factory, and we hope that those who are prevented by dis-

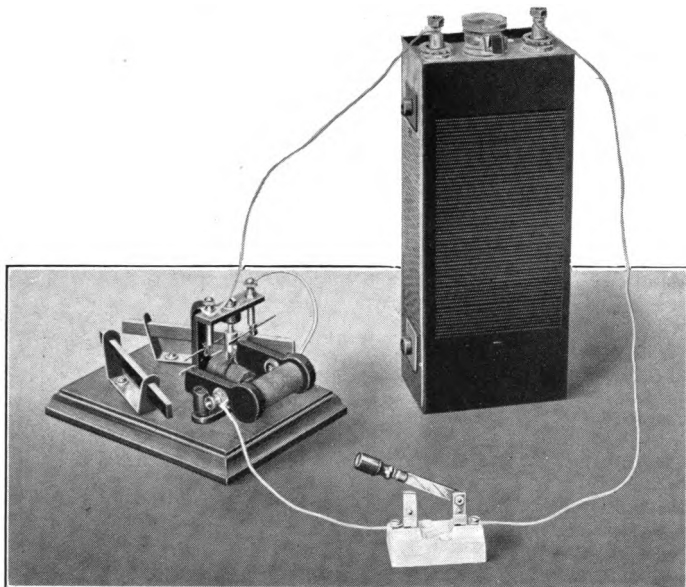

Lecture table demonstration of a "St. Louis" motor using Edison Storage Cell for power.

tance from doing so in person, will visit us by letter as often as questions regarding the battery or its use present themselves.

For assistance in preparing this Monograph we are indebted to the members of the Joint Committee: J. A. Randall, Pratt Institute, Brooklyn, N. Y., Chairman; P. B. Woodworth, Lewis Institute, Chicago, Ill.; E. E. Burns, Joseph Medill High School, Chicago; W. E. Tower, Englewood High School, Chicago; C. M. Westcott, Hollywood High School, Los Angeles, Cal.; Dr. W. A. Hedrick, McKinley Manual Training School, Washington, D. C.; H. M. Campbell, Bayonne High School, Bayonne, N. J.; J. C. Packard, Brookline High School, Brookline, Mass. Thanks are also due to the Standard Scientific Company, New York, for the loan of the educational apparatus shown in the cuts.

January, 1916.

EDISON STORAGE BATTERY COMPANY



Search for the Ideal Storage Battery

BETWEEN the actual and the *ideal* there is always room for development. Therefore it seems advisable that the student become familiar with the characteristics of an *Ideal Storage Battery*. Then, keeping the *ideal* before him, he will find it intensely interesting to read and observe the different theories advanced and the difficulties that have been overcome in the efforts to reach the *ideal*.

The Ideal Storage Battery is an electrolytic cell in which electrical energy may be stored as chemical energy until ready for use. It must be capable of returning at any time, all or any part, of the electrical energy put into it; and when emptied, the cell must be in its original condition.

To obtain this ideal battery, it is necessary to find a *perfectly reversible chemical reaction* whose direction and energy relation is perfectly controlled by the electric current. That is, first, no chemical action should take place except that which necessarily accompanies the flow of useful current when on charge or discharge; and, second, the quantity of material whose chemical composition is changed should be proportional to the quantity of electrical energy passed through the cell.

To be *ideal* the cell must be of maximum commercial value. It must be durable; light in weight; compact; sufficiently strong to stand the abuse, carelessness and negligence of a bustling world. It must be dependable: always ready for work at full rated capacity. Therefore, it must never be laid up for repairs through deterioration or other troubles due to short circuiting, over-charging or too rapid discharging. No expert attention should ever be necessary and, therefore, the general care and instructions for operation should be simple. The life of the *ideal* battery would of course be practically unlimited, and the cost of maintenance and repairs negligible.

Keeping this brief outline of the *ideal* battery in mind, let us study the history of storage battery development; let us note to what degree the *ideal* has been approached by the battery of today.

The earlier discoveries and investigations naturally related to the search for a combination of elements which would give the desired re-



Industrial Electric Trucks are an economic factor widely adopted for transporting freight and baggage in railway and steamship service. In and around manufacturing plants they are used extensively for delivering loads where electric cranes are not practical.

versible chemical cycle. These are outlined by George D. Shepardson, M. E., Professor of Electrical Engineering in the University of Minnesota, in his *Electrical Catechism*, * page 151, as follows:

“The earliest note of this was a discovery by Gautherot, who found, in 1801, that silver or platinum wires used for decomposing water by the passage of an electric current would send a current in the reverse direction when the battery was removed. This was studied further by Ritter, De la Rive, and Grove, who developed the gas battery. The modern storage battery is developed from the work of other experimenters with lead electrodes. Faraday, in 1834, found that lead peroxide $[PbO_2]$ deposited by acetate of lead $[Pb(C_2H_3O_2)_2]$ would give a current in the opposite direction from that originally causing the decomposition. In 1854, Sinstedden used plates of lead, silver and nickel in a voltmeter and obtained reverse currents strong enough to heat a wire to incandescence. In 1860, Planté sent currents through two sheets of lead, which were separated by canvas and immersed in acid, and he obtained a much more powerful and durable secondary current than had Faraday or Sinstedden, and he is generally looked upon as the discoverer or inventor of the storage battery. Planté found that the capacity of his lead secondary battery increased with use, finding that the surface of the lead was changed into sulphates and oxides and that these coatings became deeper and deeper with use. In 1881 Faure found

that the oxide might be applied mechanically more cheaply than by forming from the plate, and his pasted cell came into extensive use.”

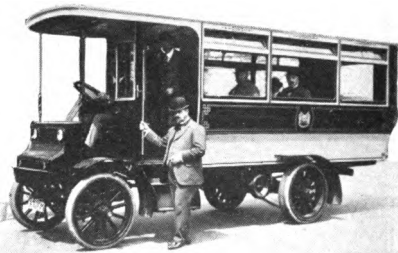

The Electric Omnibus is clean, safe and speedy.



Big loads are delivered promptly and cost of maintenance and operation are reduced when Electric Trucks replace horse-drawn vehicles in heavy hauling and van service.

*McGraw-Hill Book Co., N. Y. 1908 Edition.

Lamar Lyndon in writing concerning the Planté cell (page 147, *Storage Battery Engineering*) * states:

“The Planté process derives its name from Gaston Planté, who, in 1860, first produced a practical storage cell by passing current between two lead plates immersed in dilute sulphuric acid. After the

area to the action of the ‘forming’ process for a given size of plate.

“The PbO_2 formed on such plates is mechanically held in the interstices. With positive plates, it is advisable to retain

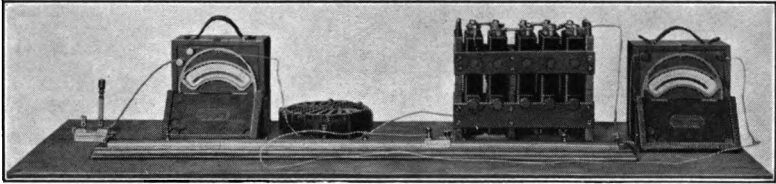

Battery of Small Edison Cells furnishing power for Wheatstone bridge and fall of potential experiments.

expiration of a short time, a slight coating of peroxide of lead was formed at the anode, the cathode being unchanged. On reversal of direction of current flow, the peroxide was reduced to metallic sponge-lead by the hydrogen—the peroxide element having become the cathode—and the previously unattacked plate was peroxidized. This, then, constituted a storage battery, but of negligible capacity, as the layers of active material were infinitesimally thin, owing to the fact that the action of the oxygen on the lead can penetrate no further after a layer of peroxide has been formed.

“By repeatedly reversing, Planté was able to increase the depth of the coating of active material sufficiently to produce a storage cell that compares favorably with any cell made today. It required, however, several months to do this, and was very wasteful of electrical energy. Therefore the process is not a practical commercial one, but based on Planté’s original work, accelerated processes have been developed. All processes which produce active material upon the plate, and out of the base lead of which it is made, are now termed Planté processes.

“Since the layer of active material formed from the surface of a lead sheet is very thin, it is necessary to provide a large surface in order to form an appreciable volume of it. An ordinary sheet of lead subjected to a ‘forming’ process would have so small an amount of active material produced on it that the resulting electrode would have but little capacity.

“For this reason, and also to provide secure lodgment for the active material, it is customary to make electrodes with grooves, ribs, laminations or other surfaces which present a greatly increased

the active material between ribs or in pockets, as it sheds rapidly from exposed surfaces.

“Manufacturers frequently claim that the area of a ribbed or grooved plate is many times greater than the product of the length by the breadth. This is true only when the plate is unformed, and before it is ready for service. After formation the spaces between the ribs or laminae are practically filled up with active material, so that the area exposed to the electrolyte is substantially the same as that of the planar surface.

“The various methods of subdividing the surfaces of the lead plates to give a large area for the formation of active material are: *Scoring; swedging; grooving; laminating; casting.*”

Concerning the Faure type of cell, Lyndon says—(Ibid., Page 171.)

“In 1880, Camille A. Faure, in France, and Charles H. Brush, in America, independently, and practically coincidentally, produced the storage battery ‘pasted’ plate, consisting of an antimonious lead grid, to which the active material was mechanically applied. The original Faure cell had both the positive and negative plates coated with minium or red lead, which is an oxide of lead Pb_3O_4 . A comparatively short time was required to change the Pb_3O_4 to Pb_2O_3 (or PbO_2) when connected as an anode, or to Pb when connected as a cathode, and the finished elements gave a high capacity per unit of weight.

“In this latter respect the pasted plate battery is superior to the Planté. All batteries in which a minimum weight is required can best be produced by the Faure system. It has the disadvantage, however, that the active material on positive plates

*McGraw-Hill Book Co., N. Y. 1911 Edition.

has a tendency to 'shed' or drop away from the grid, and the life of a pasted electrode in continuous active service is short compared to that of a Planted plate.

"This trouble has been partly overcome by the use of envelopes and shaping of

grids to hold, more firmly, the applied material.

"Numerous types of grids and varieties of active material have been devised and are used in the manufacture of pasted plates."

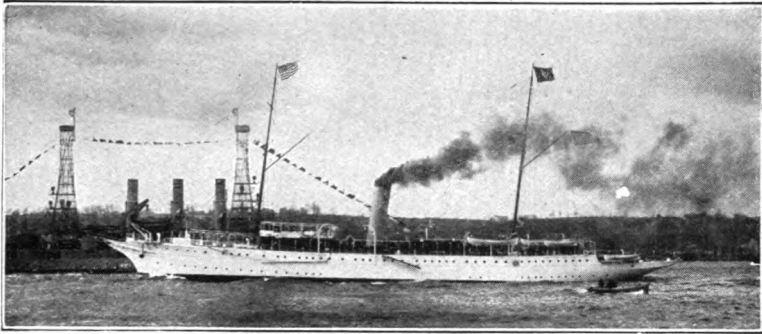

The President's yacht, "Mayflower." Equipped with 100 Edison Cells, Type B4.

For a description of the mechanical processes for forming these lead plates and more examples of this construction, the reader is referred to Lyndon's text. He states (Ibid. page 181) concerning grid construction :

"Pure lead does not possess sufficient rigidity to make a suitable grid where the active material is mechanically applied. If the grid be slightly bent, the active material is likely to crack off. While this is also true of Planted plates, it is so only to a limited extent, as the active material is much thinner and usually formed on small surfaces independent of each other. It therefore becomes necessary to mix with the lead some metal or metals which will give this needed strength and resistance

against distortion, but which, at the same time, will not materially change the voltaic characteristics of the grid.

"The metal most commonly used is antimony, and the proportions of the alloy vary from 88 per cent lead and 12 per cent antimony to 98 per cent lead and 2 per cent antimony by weight. The most usual mixture is 96 per cent lead and 4 per cent antimony. Positive grids should have a lower percentage of antimony than negative grids."



Express companies, department stores, and many other commercial organizations find it economical to maintain and operate large fleets of Electric Trucks.

After thoughtfully considering the history, theory and construction of the foremost types of lead-acid batteries, it must be evident that a search for the *ideal* among acid combinations seems to have fallen far short of the mark. The chemical process is not *completely reversible*. Chemical action takes place which is *not* accompanied by the flow of useful current. There is deterioration, rapidly decreasing capacity, until at least one set of plates has to be replaced. Other troubles, inherent in the very structure of lead-acid batteries, will be clearly perceived by the student searching for the *ideal*.

The Nickel-Iron-Alkaline Cell

ABOUT 1898, Thomas A. Edison first realized the tremendous field awaiting the development of a dependable commercial storage battery, free from the self-destroying diseases of the lead-acid type battery, and light enough in weight to make practical electrical transportation. Today this field is expanding in proportion to storage battery

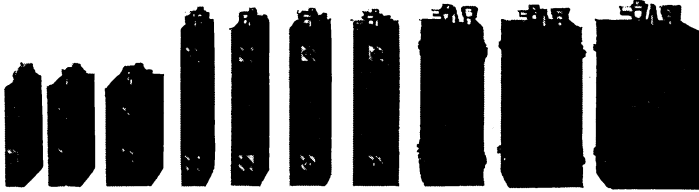

B2 B4 B6 A4 A5 A6 A7 A8 A10 A12
Standard Edison Cells, A and B types.

development and demonstration. Electric Trucks and Passenger Cars; Train Lighting and Railway Signaling; House Lighting in rural communities not reached by the Central Station; Mine Locomotives and Miners' Lamps; Wireless; Yacht Lighting—these are some of the practical uses for storage batteries.*

Mr. Edison had especially in mind the transportation field. He was firmly convinced that electrically-driven trucks must eventually be recognized as the most efficient and economical means of transportation. The problem was to find a better storage battery than was at that time in use.

Mr. Edison was thoroughly familiar with the characteristics of lead-acid storage batteries. He believed that the *ideal* battery could never be produced in a combination wherein the elements are attacked by the solution in which they are submerged. Therefore, he avoided every combination requiring acid.

A storage battery is commonly looked upon as a receptacle in which to *store electricity*. Electricity is not concrete matter. In fact, nobody knows just *what it is*. Therefore, in the general apprehension of the term, it is not *stored*. Electricity simply causes a chemical change to be effected in certain substances, when it is caused to flow through them. These substances, in endeavoring to return to their original state, produce electricity.

Suppose we place two pieces of very thin bright steel out of doors for a few weeks. They become "rusted." The action of the oxygen on the outer layer of the metal has formed it into an oxide commonly known as "rust."

Now let us place these two pieces of steel in a solution composed of potash and water, and connect them by wires to a small dynamo. The electricity, in flowing from the dynamo through the solution, from one of the plates to the other and back to the dynamo, changes the rust to metallic iron on one of the plates, but causes the other plate to become "rusted" twice as much as before.

Now let us disconnect the plates from the dynamo and connect them, by means of pieces of wire, to an ammeter (an instrument for measuring

*For Bulletins describing these applications, address Edison Storage Battery Co., Orange, N. J.

electricity). Instantly, the excess of oxygen in the rust on the one plate commences to pass back to the bright plate and, by so doing, causes electricity to be generated. Why? Nobody really knows.

We have now charged and discharged a primitive storage battery.

Instead of two thin rusted steel plates, let us mount, say, one hundred such plates, equidistantly spaced, on one rod, and one hundred more on another rod. Now interpose the two groups so the plates of one group will not touch those of the other and immerse them in a solution of potash. When connected to our dynamo the electricity will flow from one group, through the solution, to the other group, converting the oxide of one group to metallic iron, and increasing the amount of oxide on the other group. We shall be able to get much more electricity from the battery thus formed, because of the greater plate *surface* exposed.

We have thus determined that large *surface* is necessary.

Let us next place a quantity of fine particles of iron rust in two perforated flat steel pockets and, after putting these pockets into potash solution, pass electricity from one to the other, through the solution, as before. All the iron rust in one pocket will be changed to metallic iron, because the oxygen will have passed over to the iron rust in the other pocket, causing this material to possess twice as much oxygen as before.

Connect the two pockets to an ammeter and you will find that much more electricity is flowing than before, although the two pockets take up much less space than the two hundred steel plates. The reason of this is, the small particles present a very great combined surface to the solution.

Suppose, after having made a great number of experiments, you put some iron rust or iron oxide into perforated steel pockets, and mount a number of these pockets in a steel grid or support to form one plate, and place nickel hydrate (a green powder) in perforated steel receptacles, and mount them on another steel grid to form the other plate, then immerse the whole in a solution of potash—you will have arrived at the point Mr. Edison reached when he invented the *Edison Storage Battery*. And then Mr. Edison started to perfect this invention—as he had done with all his others—before giving it to the public. He perfected the mechanical details—adding a bit of steel here to increase the strength and eliminating unnecessary material to decrease weight. He perfected the active material and electrolyte—producing by new processes a purity that the arts had never before required, and by experiment obtained a nicety of proportions that gave the longest life without excess of any ingredient. He perfected a factory full of special machines, and appliances—completely designing many of the tools to make the various parts which had no precedent in mechanical production.

For eight years Mr. Edison worked on this development, and then gave to the world the new Edison Alkaline Storage Battery. Although some of the machines which produce it have passed through two, three or four “generations,” and the earlier forms have been declared obsolete and scrapped, it is a remarkable fact and evidence of Mr. Edison’s *thoroughness* that the design, form and details of the battery itself have remained practically unchanged for all the years that have elapsed since he said O. K.

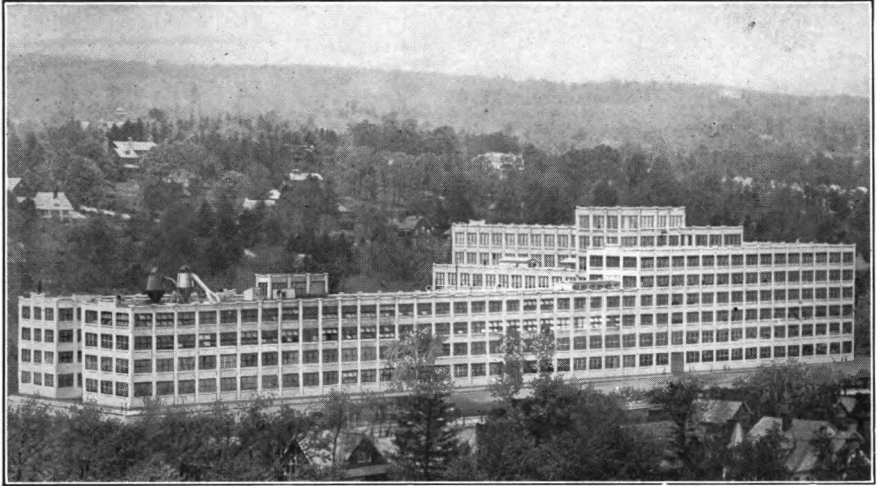

The Million Cell Plant of the Edison Storage Battery Company at Orange, N. J.

Extended as a single-story building these concrete factories would cover an area one and one-fifth miles long by sixty-two feet wide. They contain nine acres of floor space and have a manufacturing capacity of 3,000 cells (150-ampere-hour equivalents) per day.

A Trip Through the Factory

PERHAPS the easiest way to describe the manufacture of the Edison Storage Battery is to take the reader in imagination, through the factory at Orange.

Let us, therefore, enter the "Million Cell Plant" of the Edison Storage Battery Company, to observe the ingenious machines and processes that Mr. Edison found it necessary to invent, and to perfect, before the nickel-iron-alkaline storage battery could be made in commercial quantities.

One of the first Edison Batteries to be put on the market was the 150 ampere hour size suitable for operating delivery wagons, passenger electrics and similar types of small cars. This was known as the Type A4 and since then the output of the factory has been estimated in "A4 equivalents." The buildings and their present equipment have a capacity of over 3,000 "A4 equivalents" per 10-hour day — a million "A4 equivalents" per year. Mr. Edison, however, looks upon this as only a nucleus of the business awaiting development and ample room has been left in the concrete structures with their nine acres of floor space for extension in every department.

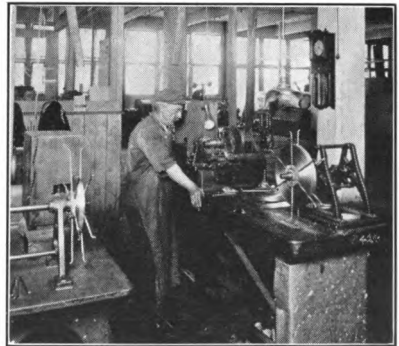

Perforating carbon steel ribbon, 560 holes to the square inch.

In being shown the construction of the cell the first things to take up are, naturally, the "plates" that hold the active materials — nickel hydrate in perforated steel tubes for the positive, and iron oxide in perforated steel pockets for the negative.

These perforated steel pockets and perforated steel tubes are made from cold rolled carbon steel ribbon which passes between two rollers. One roller has small projections on its surface; the other roller corresponding depressions. The ribbon comes out filled with regular rows of rectangular perforations, so small that 560 are included in one square inch. This perforating is necessary so that the potash solution may come in contact with the iron oxide and the nickel hydrate, and the necessary chemical action take place.

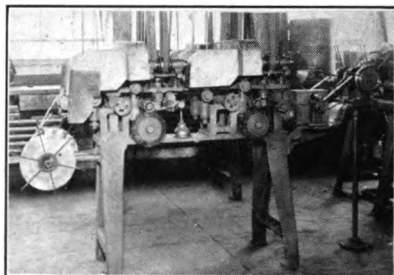

The perforated steel ribbon "zig-zagging" between the cleaning brushes.

To remove any little burrs that might remain after the perforating process, the ribbon is ground by emery wheels that smooth the rough side. But, emery dust gets into the little perforations, and to clean them the ribbon is fed through a machine with six revolving wire brushes. As it zig-zags up and down, on its way through the machine, two brushes rub one side, two the other side, and two brush cross-wise—the ribbon emerges with every perforation perfectly clean.

The ribbon is then nickel-plated. It is drawn from a reel and travels in and out through a series of tanks containing respectively, a potash solution; hot water; a double solution of nickel ammonium sulphate; hot water; cold water; and ammonium hydroxide. Pulley wheels located above and in the bottoms of the tanks guide it, the lower wheel being made of non-conducting material. The potash solution removes all oil and grease; the hot water removes the potash; the double solution of nickel ammonium sulphate is the nickel-plating bath; the hot water again washes it and dissolves any salts that may have lodged in the perforations; the cold water removes what the hot water does not; and the ammonium hydroxide removes all

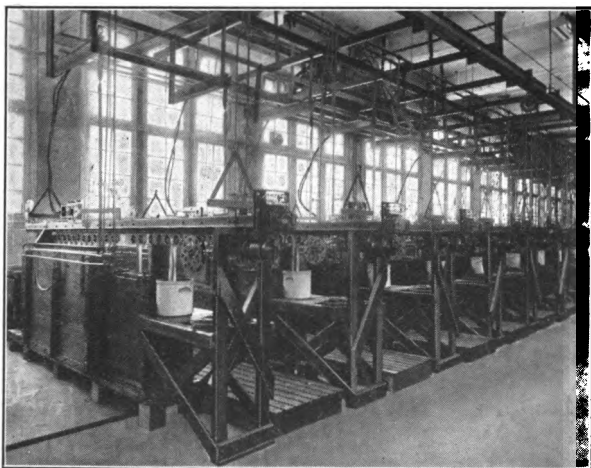

Traveling in and out through a series of baths, the perforated steel ribbon is subjected to a continuous nickel-plating process.

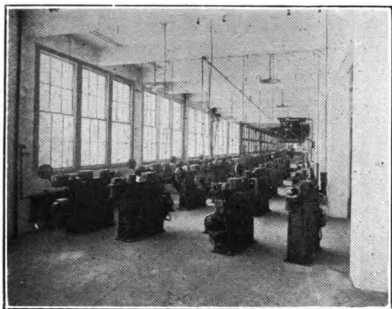

From ribbon to completed tube in one operation. Each machine makes 20,000 tubes a day.

put in an oil-burning furnace. To prevent oxidation or discoloring of the nickel-plated material, while under the action of the extreme heat of the furnace, a stream of hydrogen gas is constantly passed through the crucible, keeping the ribbon in an "inert" atmosphere.

All steel parts used in the Edison Cell are annealed in this manner. In the annealing process the nickel-plating is fused or welded to the steel itself. Thus it becomes an integral part of the steel and removes the possibility of the nickel coating peeling off or being chipped off.

Before being nickel-plated and after being annealed the ribbon is weighed and micrometer readings taken to make certain that the nickel is properly deposited.

The ribbon is prepared in two widths, the narrower being used for the negative or iron oxide pocket. The negative pockets are formed in halves not unlike the well-known paper scarf-pin box in which the box proper and cover are approximately equal, one fitting over the other. Groups of punches cut the ribbon to required length and stamp the halves into form. The halves are then slid together, forming the pockets. One end is left open for filling with iron oxide.

The ribbon for the positive tube is fed automatically into a machine through a shaping die that not only forms it spirally into a tube $\frac{1}{4}$ inch in diameter, but laps the edges of the ribbon over each other, forming a perfect joint. This lapped-over seam is pressed flat or swaged, and

trace of acid that may remain from the nickel-plating bath.

It takes eight minutes for a given point on the ribbon to pass through the entire process.

After being nickel-plated the ribbon is dried. This prevents any rust forming during the brief interval before it goes to the annealing furnaces.

From the drying oven it is placed in a crucible. The crucible is hermetically sealed and as much air exhausted as possible. The crucible is

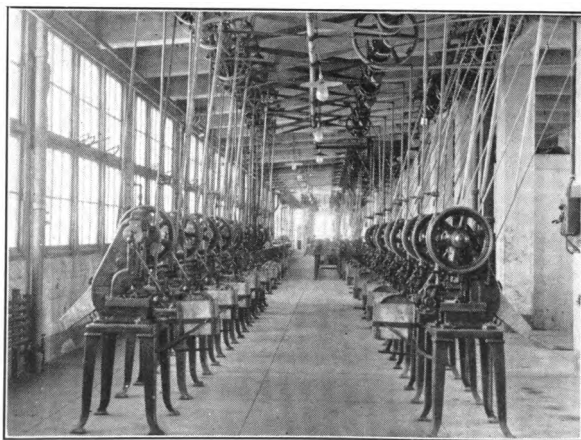

The negative pocket "halves" are formed from the ribbon by one blow in these perfected die-stamping presses.

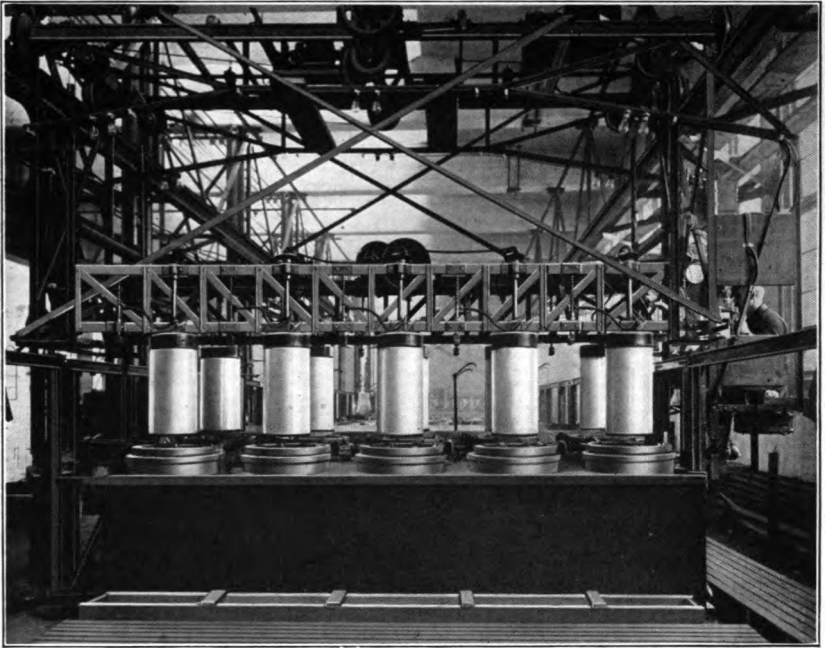

The first process in making nickel "Snow Flake." Plating 250 alternate layers of extremely thin nickel and copper on revolving cylinders.

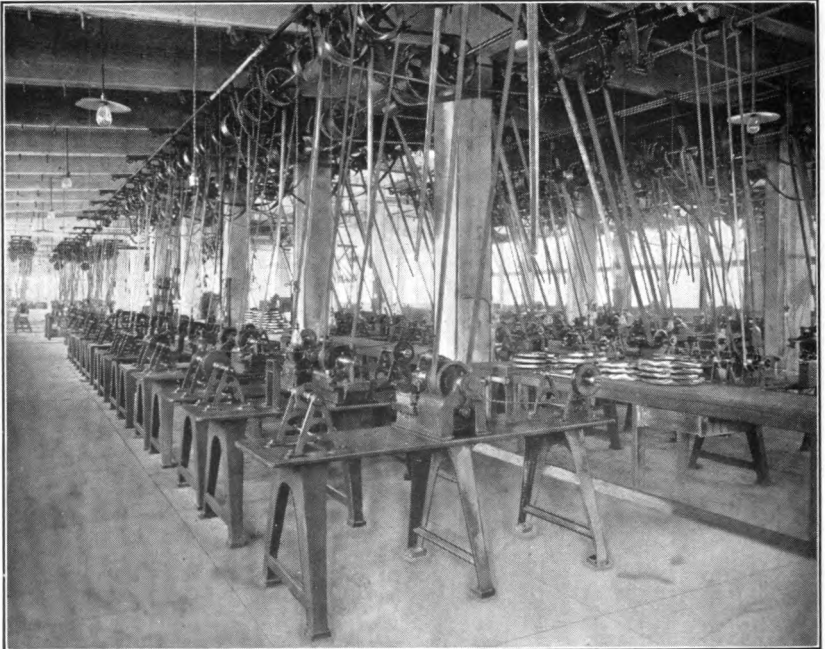

Perforating machinery. The active material is held in tubes and pockets made of perforated steel ribbon. The cutting and finishing of these perforations is one of the most interesting processes in the manufacture of the Edison Cell.

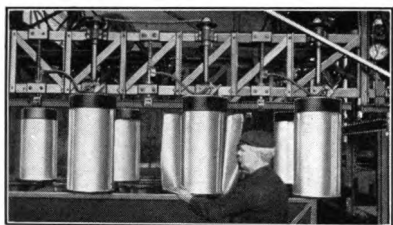

Stripping copper-nickel sheet from cylinder. The sheet is .0075 inch thick.

chine before he can make it produce a normal output of 20,000 tubes a day.

The positive tube is ready to be filled. Ordinarily to fill it with nickel hydrate would be neither difficult nor interesting, but there are certain electrical characteristics wanted that gave Mr. Edison many sleepless nights before they were obtained.

The electricity in flowing through the solution from the positive element (nickel hydrate) to the negative element (iron oxide) causes the oxygen in the iron oxide to come over to the nickel hydrate. This oxidizes the hydrate and forms nickel oxide or peroxide. This nickel oxide has comparatively high electrical resistance, so it is advisable to divide it up into very thin layers and to conduct the electricity to these layers by intervening layers of metal.

Pure nickel is not difficult to obtain, but to get it in the form required for loading the positive tube, is an original and interesting process.

After a multitude of experiments to obtain a layer of thin conducting metal that would prove satisfactory electrically and yet have as long a life as the rest of the battery, the plan was conceived of using "flakes" of nickel which could be loaded into the tubes the same as the nickel hydrate but which, when tamped down, would give the desired conducting element. The processes for manufacturing this nickel flake are perhaps the most interesting in the factory.

A traveling crane carrying 10 revolving copper cylinders is shown on the opposite page. The cylinders are lowered into two parallel rows of 5 copper baths each corresponding to the 10 cylinders, where a very thin film of copper is deposited on them. Then they are lifted out and travel past multiple water jets that spray them thoroughly before they are lowered into a row of nickel baths where a film of nickel, approximately $\frac{4}{1000000}$ inch thick, is deposited over the copper.

Then they travel back to the copper baths pausing at the water jets for another thorough spraying. This operation is repeated until there are 125 films of copper and 125 films of nickel.

The time the cylinders should remain in the nickel bath is accurately regulated by a circuit breaker and amperes hour meter combined to automatically permit only sufficient cur-

as a last operation, the tube is cut to correct length ($4\frac{1}{2}$ inches). In some of these machines the tubes are wound to the right, in others they are wound to the left. The purpose of making these tubes in "rights" and "lefts" will be explained later.

It is customary for a workman to have had six months' experience in setting the forming dies of this machine

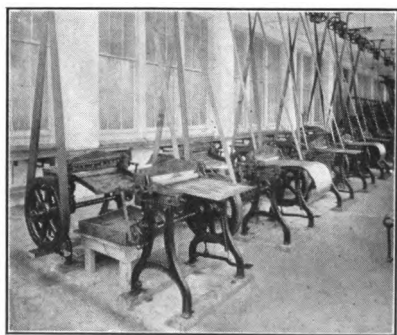

Cutting copper-nickel sheets into 1-16 inch squares. Each square makes 125 nickel "flakes" when the copper is chemically removed.

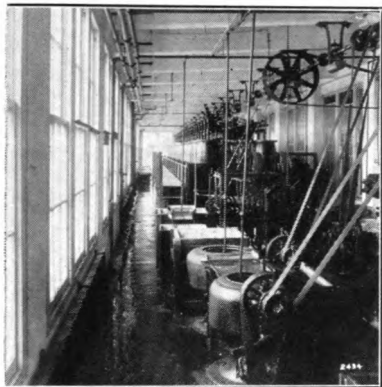

Dissolving copper from small copper-nickel squares.

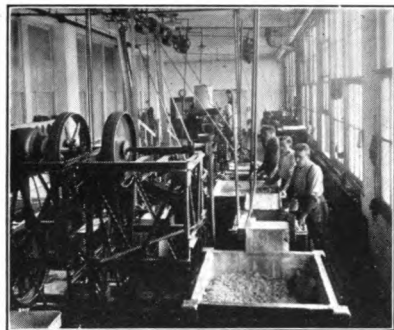

Washing the flake. Centrifugal dryers shown in the background.

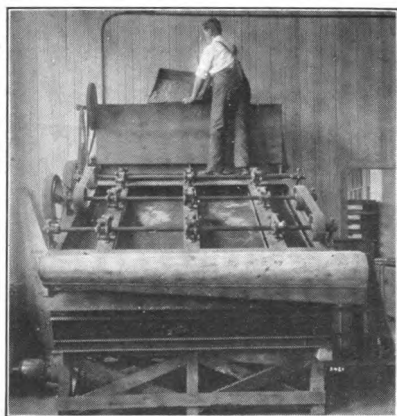

After drying over steam coils the flake is carefully screened

rent to pass to deposit a nickel film of the correct thickness. The length of time required to give the copper coating is not so important. It takes about five hours to make one 250-layer sheet .0075 inch thick.

The sheet is removed from the cylinder; cut into pieces 1/16 inch square and the pieces put into a solution where the copper is dissolved leaving thin films of pure metallic nickel. After thorough washing and the forcing out of the water by centrifugal machines similar to sugar driers, the nickel is dried over steam coils, screened and sent to the tube-loading machines—the thinnest, lightest, pure metal product ever used in a manufacturing process, nickel “snow-flake.”

It would take 85 flakes, placed one on top of the other, to equal the thickness of the paper used in this book, and a bushel weighs only 4½ pounds.

Filling the positive tubes is the next operation. Again it was found to be necessary to provide machinery of special design. The tubes are taken eight at a time and a little metal cap is inserted in the bottom of each. They are then placed in a mould and the mould placed in the machine directly under a row of fixed tubes through which metal rods pass. The tube-loading machines are also equipped with two hoppers; one hopper dumps a specific quantity of nickel hydrate, the other dumps a specific quantity of nickel flake. Then, with a force of 2,000 pounds per square inch, the metal rods ram the layers down. This process is automatically repeated until there are over 300 alternate layers (about 630 layers in all) in a tube only 4½ inches in length. As each tube becomes fully loaded, the machine automatically stops the plunger for that particular tube.

To make certain that the tube-filling machines are alternating accurately, one tube is taken from every lot filled, sawed longitudinally, and

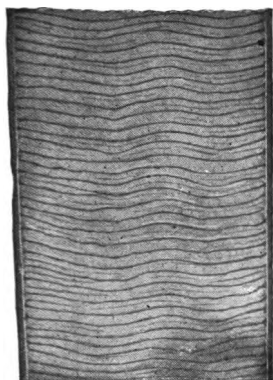

Magnified section of a $\frac{1}{4}$ inch tube. Light layers show nickel hydrate. Dark horizontal lines show nickel flake.

put under the microscope. (A magnified section is shown on this page.) Should the filling be improperly done, the error is detected promptly and that lot of tubes rejected.

Early experiment showed that the oxidizing of the hydrate had a tendency to cause the tubes to swell. To overcome this absolutely, each tube is reinforced with eight seamless steel rings, equidistantly spaced.

These little rings are punched, ten at a time, from a ribbon of highest grade finished cold rolled steel. This steel is made especially for the Edison Storage Battery Company for this particular job; if made too soft or too hard it will not do. The ribbon travels from a reel through the press to another reel on which, after the rings are punched out, it is wound as "scrap."

On its way through the punch the ribbon pauses as dies descend and punch out ten holes. Then it advances and when the dies descend again to punch out another ten holes the first ten have arrived at another row of dies which force down the inside edges of the holes making rims, or flanges, equal in depth to that of the desired rings. The dies that force down the edges are encircled with a hard steel shell that reaches the ribbon $\frac{1}{16}$ " behind the dies and cuts off the rim.

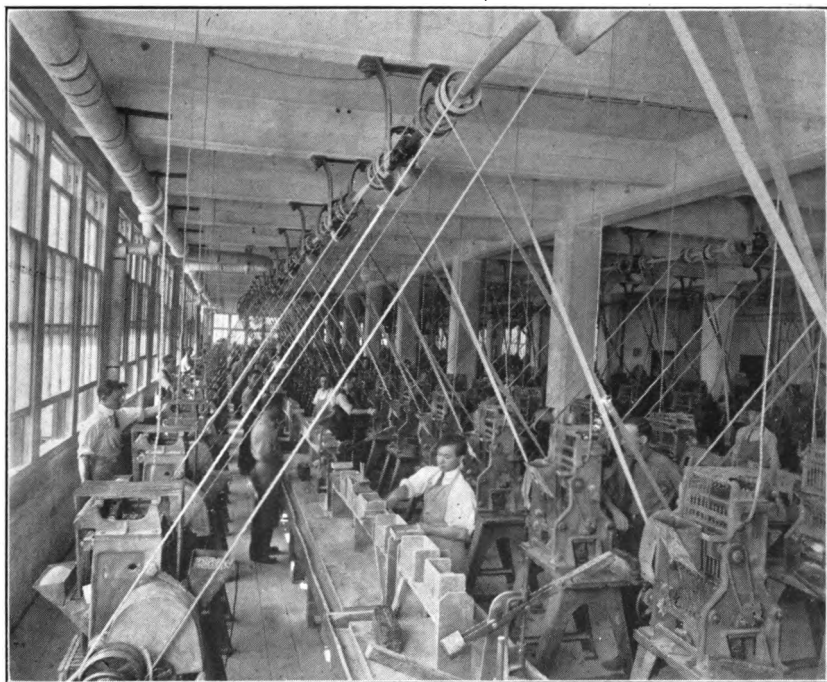

Loading 630 layers, alternately nickel hydrate and nickel flake, into a tube $4\frac{1}{2}$ inches long. See magnified section of tube above.

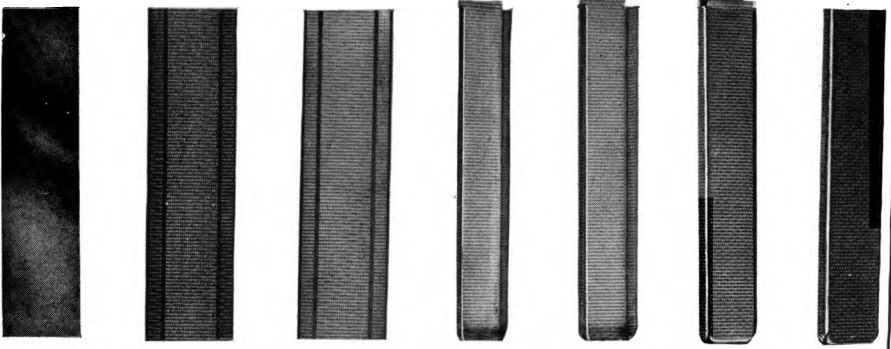

Evolution of the Negative Pocket from carbon steel ribbon to the loaded pocket. Perforated, nickel-plated, pressed into halves, the halves put together with one end open for loading. The loaded pocket.

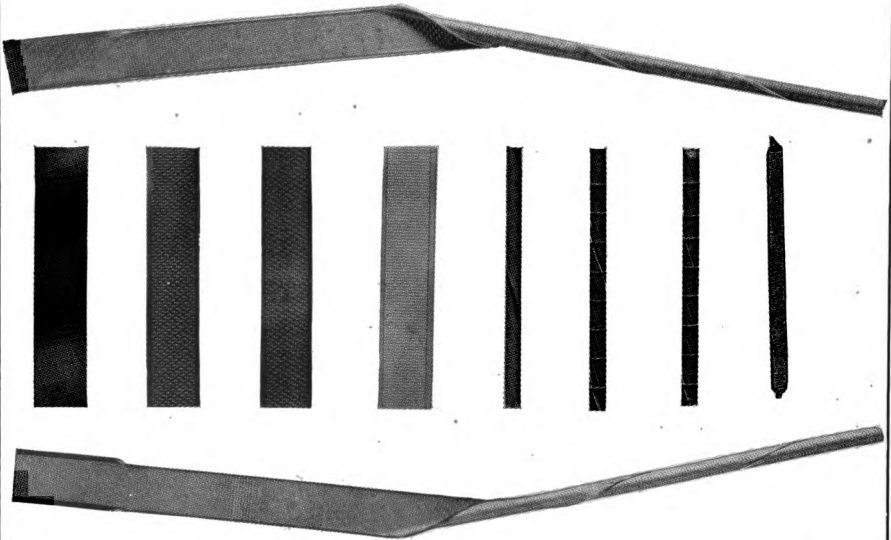

Evolution of the Positive Tube from carbon steel ribbon to the closed and trimmed finished tube. Perforated, nickel-plated, drawn into tubes, loaded, ringed. The last figure shows a tube cut longitudinally for inspection. The pieces at the top and bottom of the picture have been lifted from a tube winding machine to show operations. Note right and left hand twist.

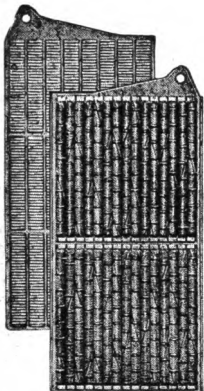

Type A — Positive plate in front, Negative behind.

It is interesting to note that the sheet steel from which the rings are made is thinner than the width of the bands. These rings, before being used, are nickel-plated and fed into a machine that automatically discards any that are imperfect.

The filled tubes and the seamless rings are put into another automatic machine. The rings gravitate into 8 equidistant grooves in such a position that the tube can be forced through them by a plunger working from the side.

After being closed, trimmed and inspected, 30 of these positive tubes are mounted on a nickel-plated steel grid and pressed into permanent position by hydraulic pressure of 40 tons. You will remember these tubes were made in "rights" and "lefts." They are mounted alternately in the grid so that

any tendency to twist on the part of one tube will be counteracted by the next one which is oppositely wound.

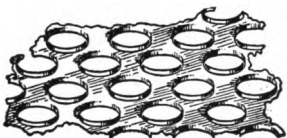

Making rings with rims of greater width than the sheet from which they are punched.

The negative pockets, which hold the black iron oxide, are filled and tamped by a method much like that used in filling the positive tubes.

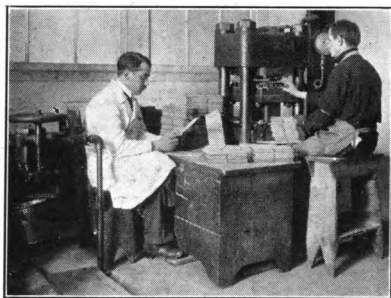

Hydraulic pressure of 40 tons secures the positive tubes in a steel grid, the last operation in the construction of a strong, durable positive plate.



Loading the Negative Pocket with Iron Oxide.

Twenty-four finished negative pockets are placed in the openings of the negative grid. Hydraulic pressure of 120 tons is used to clamp them firmly to the grid. It also corrugates the sides of the pockets, imparting sufficient elasticity to cause them always to adhere tightly to the iron oxide mass within and strengthens each individual pocket.



Type A4 cell removed from container.

For a Type A4 Edison Cell four positive plates are mounted on a steel rod, to which has been attached a vertical pole, the plates being equidistantly spaced by means of steel washers. Similarly are mounted five negative plates. "Intermesh" the four positive and five negative plates so that they will be alternately negative and positive, keep these plates from touching by putting hard rubber rods or pin insulators between them, fit hard rubber ladder pieces or grid separators to the edges of the plates, and the elements are assembled and ready to place in their container.

The container is made of nickel-plated sheet steel with sides corrugated to increase its strength. The single side seam is welded by the oxy-acetylene blow-pipe and the tops and bottom welded on in the same manner.

The assembled elements are now placed in the container with thin sheets of hard rubber, on the sides not already insulated by the grid separators. A hard rubber washer is dropped on each of the vertical pole pieces, and the cell is ready to have the top *welded on*. It is not necessary to see the inside of the cell again.

The fittings through which the vertical poles pass are provided with soft rubber washers, and with rings and gland caps for expanding these soft rubber washers to form a gas-tight and liquid-tight packing between the top of the container and the poles.



Making the Edison Container a one piece can by oxy-acetylene welding.

The top of a Type A4 Cell with cover welded on is shown on this page. The aperture for putting in solution, or adding distilled water is in the valve box in the center. In the top of the lid is a little valve which allows the gas generated during charging to get out, but no impurities or air can get in.

When any storage battery is charged, hydrogen gas forms on the negative plates and oxygen gas on the positive. These gases, in the form of minute bubbles, rise to the surface of the solution and, being lighter than air, float away.

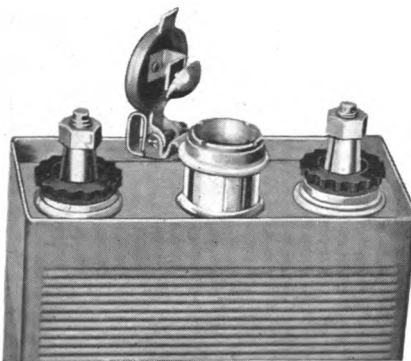

Top of Cell showing check valve and filling aperture for adding distilled water.

Being formed in and subsequently passing through the solution, these minute bubbles each convey a small particle of whatever chemical the solution is composed; if they are formed in a lead-sulphuric acid battery, sulphuric acid is the cargo; if in an Edison Alkaline Battery, potash.

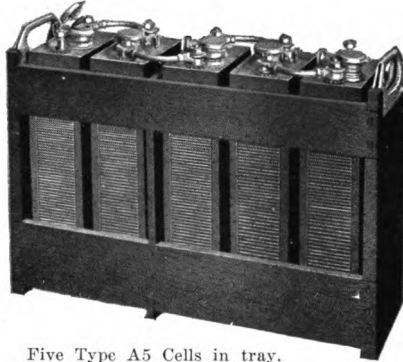

Five Type A5 Cells in tray.

When these bubbles rise from the surface of the electrolyte and come in contact with an object, they either remain until evaporation disintegrates them and deposit their cargo of acid or alkali, or they burst and accomplish the same result.

The vent of the Edison Cell is the check valve described above. To get out, the gases must *lift* this valve, by pressure formed within the otherwise hermetically sealed steel containing can. In doing so, a great majority of the little bubbles are burst, and the potash drains back into the cell. A few of them get by and float harmlessly away.

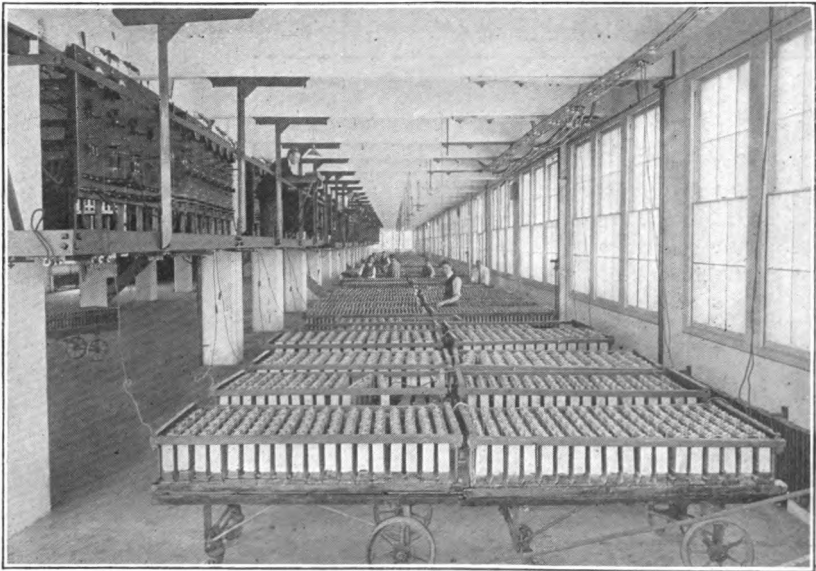

Part of Testing Department or Forming Room. The four complete cycles of charge and discharge necessary to establish the electrical characteristics of an Edison Cell are performed in a department not isolated from the remainder of the plant.



The Positive and Negative Plates are assembled on their respective pole pieces and intermeshed, after which they are assembled with special hard rubber insulators in a steel container and the top is welded on.

When newly assembled, cells are charged and discharged until their electrical characteristics become fixed, they are then said to be "formed." The part of the plant where this is done is known as the Forming Room. Each cell is given 4 complete cycles of charge and discharge, during which voltage readings of each cell are taken periodically.

If any cell fails to come up to the standard in voltage and ampere-hour capacity required, or if it acts peculiarly in any way, it is rejected.

Before shipping, each cell is dipped into a special paint or insulating compound. This compound will not get brittle or crack at low temperature nor lose its mechanical and electrical qualities at high cell temperature.

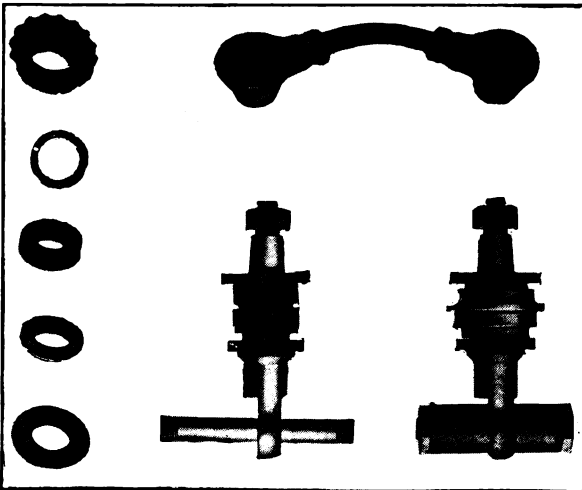

The construction shown makes a gas-tight and liquid-tight packing between the top of the container and the poles. The steel lugs of the standard Edison Cell Connector shown at the top of the picture, are exactly tapered to fit the tapered steel poles. When forced into position by the pole nuts, the contact is made perfect.

The cells are assembled in wooden trays to facilitate handling. The Edison Battery Tray is extremely simple, light and strong and the cells are thoroughly insulated from it and from one another.

The cells are supported by bosses on the sides of the steel containers which fit into hard rubber buttons in the side slats of the trays and give a rigid, clean and well insulated assembly, easily taken apart when required.

Normal Characteristics of the Edison Storage Battery

THE characteristic curve shown below, recording the normal charge and discharge of Type A and Type B Edison Storage Battery Cells, shows a strictly conservative result. The card was plotted from the results of a series of actual performances, and the data corroborated in all important respects by impartial tests conducted at the Electrical Testing Laboratories of New York City. It is the unvarying custom of the Edison Storage Battery Company to have all important tests checked up and verified by the highest available outside authority, so that there will be no possibility of prejudiced statements being made.

As the result of this policy, rigidly enforced in practice, it is found that cells as commercially manufactured have surprisingly uniform capacity; and that under any similar conditions, no matter how abnormal, different cells will give practically identical results. The same characteristic of constancy of behavior applies also to the different sizes of cells, and at comparative rates they have similar characteristics, except for slight variations in heating due to differences of radiating surface.

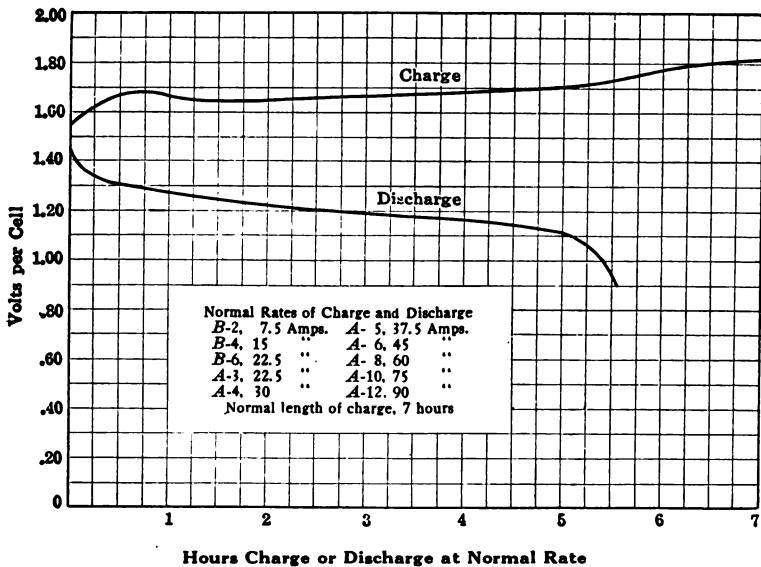

Fig. 1—Curves showing a discharge at the 5-hour rate and a normal 7-hour charge. A and B Type cells.

For all practical purposes, therefore, it is safe to assume that what is true of any single cell will hold good for a battery of any number of cells, if subjected to the same conditions; and, furthermore, that a result or curve taken from one size of cell will apply to other sizes equally well if the rate and output figures be made proportional.

The variation in voltage on charge and discharge at normal rate is shown in Fig. 1.

Emergency Characteristics of the Edison Storage Battery

FROM time to time cells are subjected to various kinds of abuse estimated to be many times as severe as they are likely to experience in actual service. A brief description of a few of these tests, with the self-explanatory curves will serve to acquaint you further with the Edison Storage Battery and particularly its capacity to endure abuse.

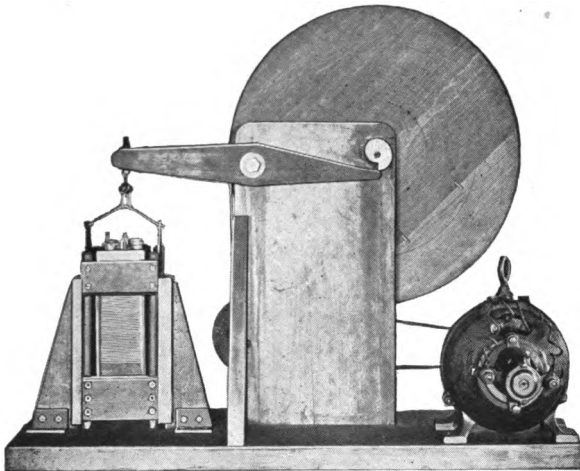

Fig. 2 — The Edison Cell had to stand up to nearly 2,000,000 "falls" from a height of $\frac{1}{2}$ -inch in this machine before manufacturing was ever considered.

Figure 2 shows an apparatus specially designed by Mr. Edison for the purpose of subjecting the Edison Cell to severe vibration and concussion. The cell was mounted in the cage and raised about one-half inch and dropped on a solid oak block. There was no cushioning between the cell and the cage. After this operation had been repeated nearly two million times, the cell was tested. Figure 3 (page 27) shows the electrical characteristics of the cell to have been unaffected.

Contrary to all reason and theory, Figure 4 (page 27) demonstrates that even carelessness in regard to keeping the plates covered with solution does no immediate damage to the cell. This, however, is not to be taken to mean that such treatment, if persisted in, would not ultimately do harm. Furthermore, if the solution be allowed to get *very* low, the density of the current passing through it will become great enough to give a very high local temperature, which will cause the rubber parts and even the metal parts to be fused.

Figure 5 shows that no injury results from connecting up a discharged cell with the polarity reversed and charging in the reverse direction at normal rate for 15 hours.

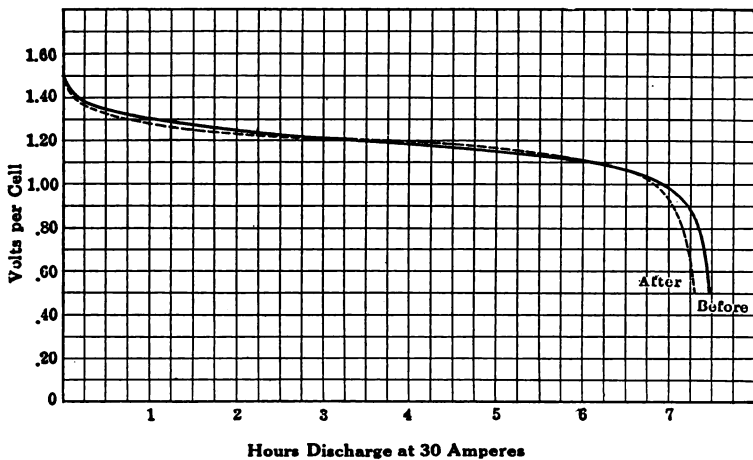

Fig. 3—Effect of Shock Test (A4 Cell). Normal rate discharges before and after the 13.5 lb. cell was lifted and dropped one-half inch on solid wood 1,776,000 times. Cell had normal rate overcharge in each case.

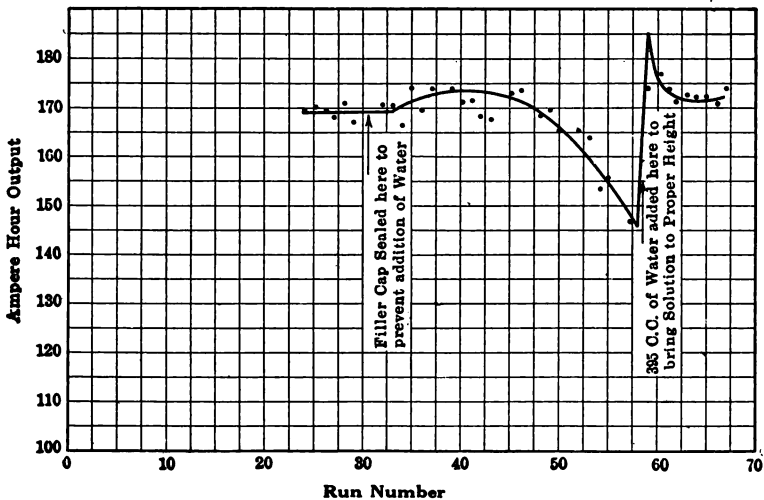

Fig. 4—Performance of a cell which was given 28 cycles of normal charge and discharge without the addition of water—which abuse lowered the solution level to $2\frac{1}{2}$ inches below tops of plates. (A4 Cell, rated capacity 150 ampere hours)

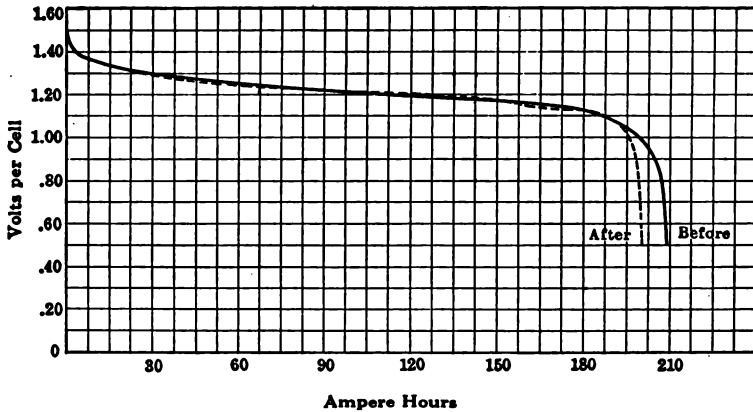
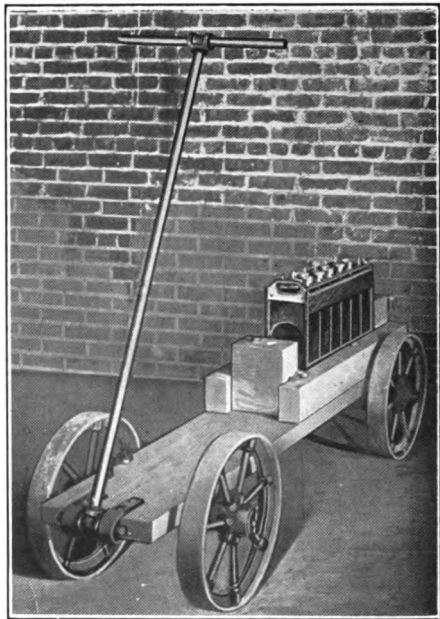

Fig. 5—Normal rate discharges before and after a long reversal treatment consisting of charging in the reverse direction, i. e., with the iron as anode and the nickel as cathode for fifteen hours at normal rate. Each discharge followed a normal overcharge of fifteen hours (A4 Cell).

Figure 6 shows successive discharges of a cell following a period of standing with the solution entirely removed. The cell was discharged before emptying the solution, and afterward was left for two weeks with its filling aperture open. This permitted the entrance of enough air to discharge the reserve capacity of the iron electrode by direct chemical oxidation, and consequently it had to be built up again before the cell gave a normal discharge curve. It took five normal-charge runs to do this, as Figure 6 shows, but could have been accomplished sooner by giving long overcharges.

Cells of other batteries suffer by sulphation when allowed to stand unused when wholly or partially discharged; and when such a battery is to remain for some time out of commission it is necessary to give it freshening charges at frequent intervals or give it a complicated shelving treatment, involving much labor and trouble. The Edison Battery can be set aside and forgotten in any state of charge or discharge for a practically unlimited length of time without fear of injury. Figure 7 shows



When Fig. 2 test was completed, the Edison Battery was mounted on this truck and the truck projected against a brick abutment 1,000 times at speed of 15 miles per hour at moment of impact before Mr. Edison would "pass" it.

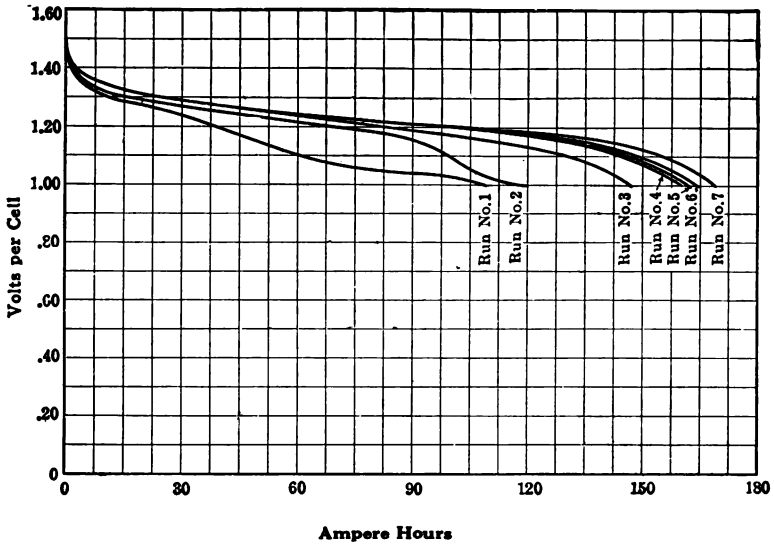

Fig. 6—Recovery after standing empty. Successive normal rate discharges immediately after standing two weeks discharged, without solution and with filler cap open. All charges, seven hours at normal rate. (A4 Cell, rated capacity 150 ampere hours.)

comparative discharges of a cell before and immediately after it had stood six months in a totally discharged condition.

Figure 8 is an interesting curve, showing the alacrity with which the Edison cell adjusts its voltage to sudden changes of discharge rate, and showing also how nearly the voltage at different rates corresponds to that of constant-current discharges at each rate. The slight disagreement between these voltage values is accounted for by variations of internal

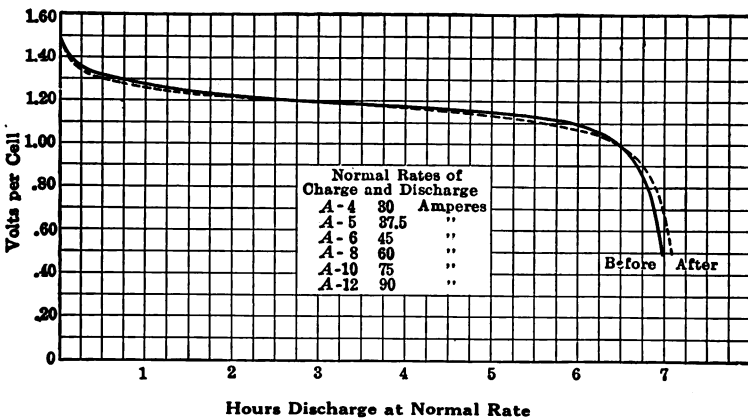

Fig. 7—Normal discharges of Cell which stood six months completely discharged. These runs were made immediately before and immediately after the stand. Normal rate overcharges were given in each case.

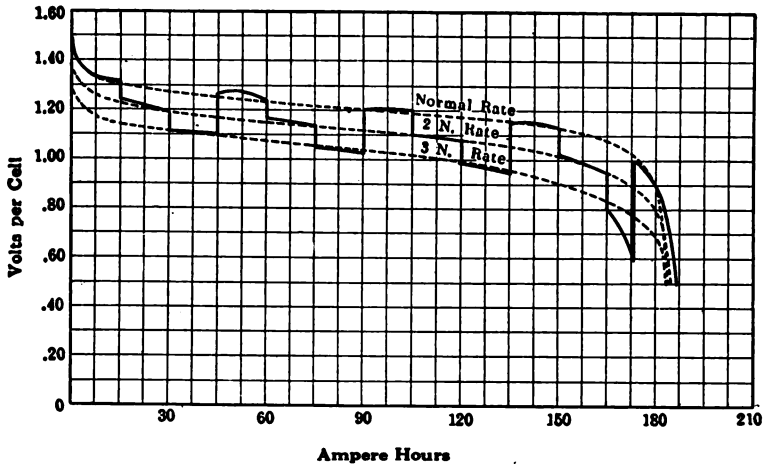

Fig. 8—Discharging at high rates. A4 Cell, normal rate 30 amperes, discharged successively at 30, 60 and 90 amperes with comparison of continuous discharge at each of these rates.

resistance due to temperature differences. The dropping off at the highest rate toward the end of the varied-rate discharge seems to indicate that it is the increased heating which causes full capacity to be given at the same high rate of *constant* current.

The Edison Cell is not injured by occasional short-circuit discharges. Figure 9 gives the current curves of four consecutive short-circuit discharges of an A4 cell, which show an actual betterment of the cell by

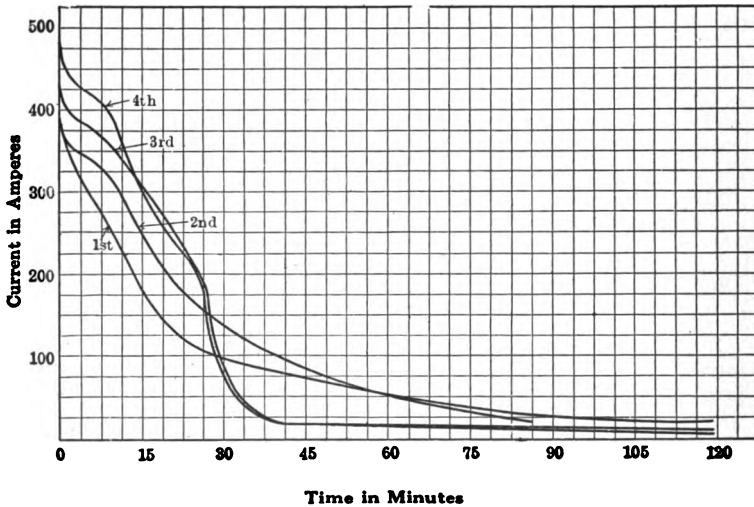

Fig. 9—Successive short circuit tests—A4 Cell charged seven hours at 30 amperes. Discharged to exhaustion through an external resistance of .0005+ohms consisting principally of the ammeter shunt.

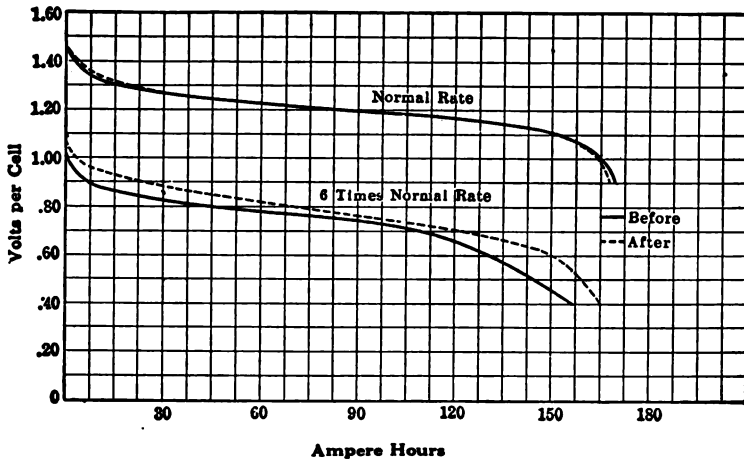
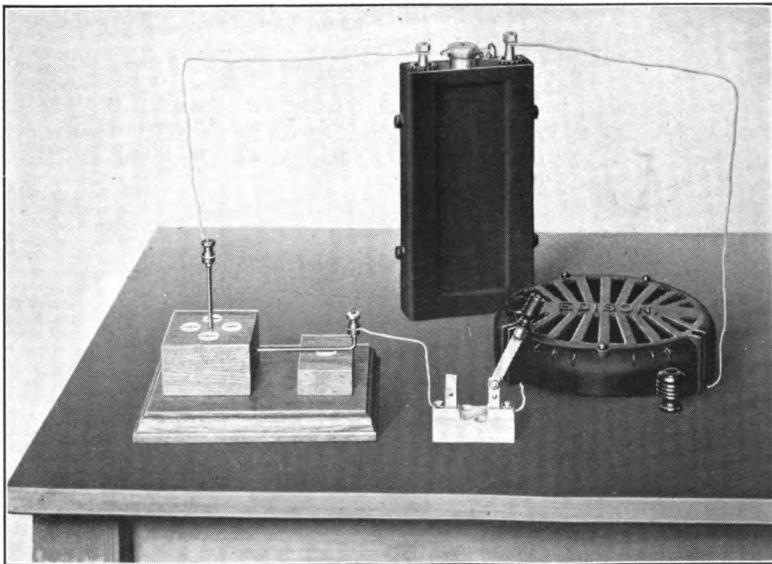

Fig. 10—Comparison of normal and high rate discharges made before and after nine short circuit discharges to exhaustion—charges at normal rate of 30 amperes for seven hours. (Type A4 Cell.)

such treatment. Nine short-circuits were given in this instance, the voltage and current increasing up to the fourth run. This betterment has been found to be due to the fact that high-rate discharges improve the conditions in the iron electrode, giving the cell stronger voltage. The improvement is hardly great enough to show on a normal discharge rate, but becomes evident at high rates, as shown in figure 10.



A small Edison Cell used for demonstrating Oersted's Law.

The Chemistry of the Edison Storage Battery

THE fundamental principle of the Edison Storage Battery is the oxidation and reduction of metals in an electrolyte which neither combines with nor dissolves either the metals or their oxides. Also, an electrolyte which, notwithstanding its decomposition by the action of the battery, is immediately re-formed in equal quantity, and is, therefore, a practically constant element without change of density or conductivity over long periods of time. Therefore, only a small quantity of such electrolyte is necessary, permitting a very close proximity of the plates. Furthermore, it is unnecessary to take hydrometer readings until about three hundred cycles of charge and discharge have been made; this is simply to determine when it is necessary to empty out the old solution and put in new. The active materials of the electrodes being insoluble in the electrolyte, no chemical deterioration takes place therefrom.

The chemical reactions in charging the Edison Storage Battery are, (1) the oxidation from a lower to a higher oxide of nickel in the positive plate, and (2) the reduction from ferrous oxide to metallic iron in the negative plate. The oxidation and reduction are performed by the oxygen and hydrogen set free at the respective poles by the electrolytic decomposition of water during the charge. The charging of the positive plate is, therefore, simply a process of increasing the proportion of oxygen to nickel. The proportions of nickel to oxygen in definite oxides of nickel are as follows:

	Atomic Proportions		by Weight	
	Ni	O	Ni	O
Ni O	1	1	1	.273
Ni ₃ O ₄	1	1.33	1	.364
Ni ₂ O ₃	1	1.5	1	.409
Ni O ₂	1	2	1	.545

The relative amounts of oxygen necessary to oxidize nickelous oxide, or NiO, which is the oxide corresponding to the green nickel hydrate used in making the battery, to the various oxides are given in the three reactions:

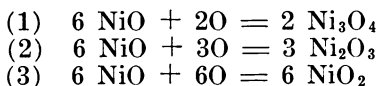

The NiO₂ is capable of reacting with NiO according to the reaction $\text{NiO}_2 + \text{NiO} = \text{Ni}_2\text{O}_3$. Ni₃O₄ is considered as a combination of $\text{NiO} + \text{Ni}_2\text{O}_3 = \text{Ni}_3\text{O}_4$.

From a chemical standpoint a charged condition of the cell would, therefore, be represented in the positive plate by an atomic ratio of nickel to oxygen of at least 1 : 1.5 (or Ni₂O₃), depending on the charge. A discharged condition would be represented by a ratio of 1 : 1.33 (Ni₃O₄) or lower, depending on the discharge.

The discharge of the cell is simply the reversal of the above reactions, the hydrogen reducing the higher oxides of nickel to lower oxides and the oxygen oxidizing the iron to ferrous oxide.

School Laboratory Uses of Storage Batteries

THERE are two ways in which storage cells are commonly installed in school laboratories. Frequently, they are connected together in a cabinet and the current distributed to the individual students through a switchboard and rather complicated set of wiring. The alternative is to have portable trays in which the cells are carried to the various students. Each method has advantages of its own, and in large schools, both are often used. For most installations, however, the use of the large amount of secondary wiring to distribute the current from a common switchboard increases the investment unnecessarily without any compensating saving of time or money in other directions. The following parallel sums up the relative merits and disadvantages of the two systems as determined by an instructor in an institution using both.

Comparative Merits and Disadvantages of Portable and Permanent Sets

(Disadvantages given in *Italics*)

Portable Sets

Low first cost

Can expand as desired by easy stages, starting with a small investment.

Connections made at the experiment. No running to switchboard by instructor in "setting up." Teacher's time saved.

No interference with other experiments. No voltage fluctuations.

Class instruction not limited to any particular laboratory or lecture room.

Batteries should be collected and grouped for charging.

Greater variety of experiments may be performed at same time.

Cells may be used as source of current or as a subject for experiment as desired.

Experiments using battery current may be made by a few students while others are doing something else.

Can be used where there is no permanent wiring.

Can be used when there is no central station supply and cells occasionally sent to nearest supply for re-charging.

Permanent Sets

Large Investment

Can take care of considerable overload (but not very satisfactorily) without increasing the investment.

In a given experiment, same connections and conditions are used. May often have to wait for an opportunity to make proper connections.

Must keep load on parallel circuits constant to avoid voltage fluctuations.

Class instruction limited to rooms where permanent wiring is installed.

Batteries conveniently arranged for charging.

Wiring may be used for other sources of current — such as rectifier or motor-generator set.

Cells used only as source of current. Must be disconnected to make experiments in battery operation or characteristics.

All students must perform battery experiments at the same time, necessitating complicated wiring and a great deal of it to reach all of the various stations.

Permanent wiring necessary for satisfactory operation.

Should not be used unless central station current is available or a private plant with gasoline generating set has been installed.

Methods of Charging an Edison Battery for School Use

The table on this page states, in an approximate way, the cost of charging by the use of the various kinds of apparatus found in schools. This information, while not exact for any conditions except those assumed should be kept in mind when the equipment of your school is being purchased.

Considering the value as an illustration of mechanical construction and design, and as an all around object of instruction, the low voltage generator in a motor generator set seems the best type of charging service for schools. The rectifier is cheap and reliable but has not so many other uses as an object of instruction.

Mention should be made here of the advantages of installing a low voltage gen-

erator, run by a gasoline motor, as a source of energy for storage battery charging and for general service. Such an equipment need not be considered as competing in cost with any of the prices mentioned in the table because of its great intrinsic educational value.

The gasoline engine, with its ignition system and governing device and the generator, with its field rheostat, furnish invaluable illustrative material for Heat and Mechanics instruction as well as for electricity.

NOTE: Detailed information concerning equipment mentioned in the table may be had upon application to the Joint Committee on Physics.

Relative Cost of Charging

Showing various means of charging B2 cells from 100 volt service. Normal rate complete charge and 5 cents per kw. hr. are assumed.

Service	Types	First Cost	Annual Up-keep and Depreciation	Cost of 7-hr. Charge per Cell in Batteries of		
				1 Cell	12 Cells	60 Cells
D C	From 110 volt D C service using series rheostat	\$5 to \$10	\$1	\$.289	\$.024	\$.0048
A C	Rectifier—8 amperes, 10 volts. 1 cell charged with series resistance. (Cost for 12 cells is computed as for 6 cells, the full capacity of the rectifier)	\$65	\$8	\$.05	\$.0083	
D C or A C	Motor generator set, 110 volt motor, low voltage generator. (No rheostat required except in generator field)	\$100	\$12	\$.11	\$.0155	
A C	Motor generator set, 110 volt generator. Series charging using a rheostat	\$115	\$13	\$.44	\$.037	\$.007
A C	Rotary converter using a series rheostat	\$60	\$7.50	\$.437	\$.036	\$.0072

The cost of the equipment is based on actual purchases made by schools previous to January 1, 1915.

Battery Tests and Laboratory Experiments

Practical Information: The Edison Storage Battery will withstand practically all ordinary mechanical or electrical mistreatment. However, the most rugged apparatus needs some attention to keep it in efficient condition. In the case of any kind of storage battery, care must be taken not to bring a lighted match or other flame near it on charge, as an explosive mixture of hydrogen and oxygen is formed by the electrolytic decomposition of the water. For the same reason, the battery should never be charged in a closed box, compartment or closet.

The student must also be careful not to break the thermometer while he is taking temperature. However, no injury is done to an Edison cell by the broken glass or the mercury.

Charging in the reverse direction will not permanently injure Edison cells. If a battery fails to show voltage on open circuit after a charge, examine the connections carefully to see that the positive lead is attached to the positive pole of the cell. The positive pole is indicated by a red hard rubber bushing at the gland in the cell cover.

An *occasional* dead short circuit will not injure the Edison battery. An Edison battery may be left standing idle indefinitely, either charged or discharged. When it is left fully charged, the charge is decreased in the first few days, by 10 to 15 per cent, but the remaining 85 or 90 per cent of the charge decreases more slowly.

The student must not put acid of any kind in an Edison battery, and he must be sure to keep the plates covered with the electrolyte. Distilled water must be added from time to time to replace that which has been lost by evaporation and electrolysis.

In order to insure maximum life and efficiency to the battery, the electrolyte should be renewed at intervals of three to six years with new electrolyte obtained from the manufacturers. The old electrolyte should not be poured out until the new is at hand and ready to be put in the cells.

It weakens the solution to take samples of electrolyte for chemical analysis from the cells. Only the samples from the renewal solution or from the old electrolyte, poured off when the electrolyte is changed, should be used.

Students should be furnished with the booklet on General Information for the particular type of Edison Cell being used. A supply of these booklets can be had on request to the manufacturers.

Laboratory Experiments: The individual experiments which are commonly done with alkaline cells cover nearly the entire list of electrical principles.

An electrical course usually starts with magnetism and electromagnetism follows. A cell may be used for giving current to show Ampere's Law, Oersted's Law and lines about a straight conductor.

For every experiment in such new manuals as those of Fuller and Brownlee, Black and Davis, and for all of the demonstrations in direct current, except those on the arc lamp and the Cooper-Hewitt Lamp, the Edison Alkaline Cells can be used.

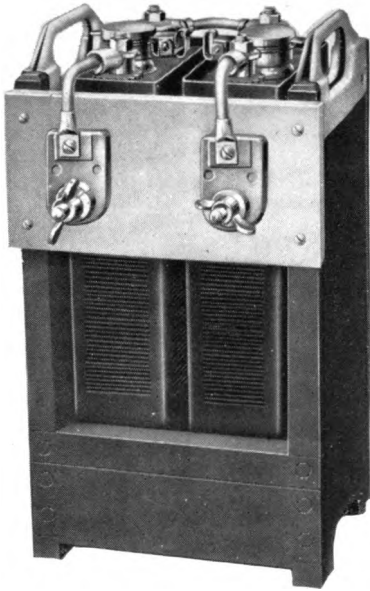

Portable sets save time and money and make it possible to perform a greater number and variety of experiments during the school term.

A few illustrations showing how the cells are connected up to do familiar experiments, are given in this Monograph as suggestions.

Commercial motors are now used in large numbers for starting automobiles which operate on 12 volts or less. Such motors now permit of laboratory work or lecture demonstrations with storage batteries which were thought impracticable two years ago.

The possibilities of the use of low voltages for lecture table demonstration have not been as fully developed as the nature of the art warrants. This is partly due to the low currents and small capacity of dry cells, and the inconvenience of wet cells for this purpose. With the advent of portable storage cells of large current and watt-hour capacity, and with the introduction of the low voltage motor, in commercial sizes, better results and greater use should follow. The

portable set with special terminals, shown above, is one of several used in the advanced Electrical Laboratories of Pratt Institute.

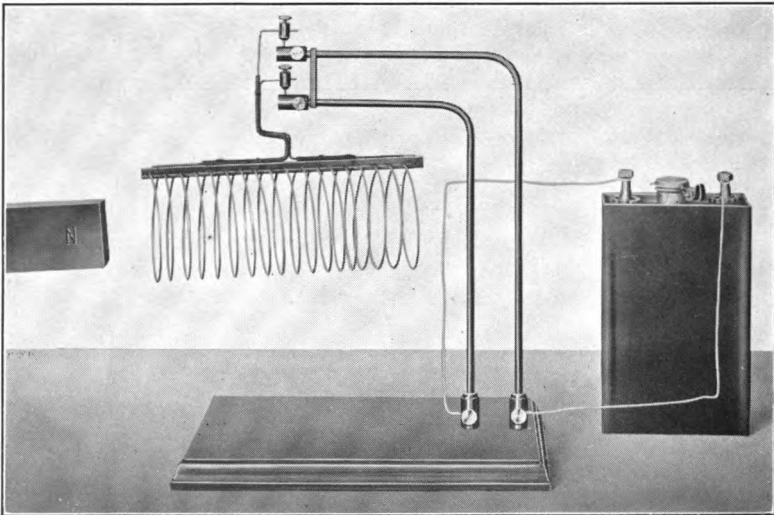

A great variety of experiments may be made at the same time with Edison portable sets. While one group of students are demonstrating Ampere's Law other groups are performing other experiments.

Determining the Characteristics of an Edison Cell

Apparatus: Edison cell discharged, ammeter, adjustable resistance, two switches, hydrometer, glass hydrometer syringe, thermometer, manufacturer's bulletins.

Preliminary: Obtain the ampere hour rating and normal charge and discharge rate of the cells from the bulletins. Note that the normal duration of charge is 7 hours, and the current rate is the same as that for a 5-hour discharge. (See Page 25, Normal Characteristics of the Edison Storage Battery.)

Charge: Connect the plus terminal of the battery to the plus terminal of a direct current supply line through a suitable variable resistance. Close the switch to power, noting the time. Quickly adjust the current to the value specified by the instructor and note the voltage. Maintain the current constant by adjusting the resistance. When necessary, take voltage and current readings at the following intervals in minutes: 0, 1, 2, 3, 4, 5, 10, 15, 20, 25, etc., until directed by the instructor to stop.

Continue to take readings of the open circuit voltage at one-minute intervals for 5 minutes.

Discharge: Connect the cell as in the diagram. Read the voltmeter and ammeter. Close the switches, adjust the current to the value specified by the instructor, noting the time, and read the instruments simultaneously at the end of the following intervals in minutes: 0, 1, 2, 3, 4, 5, 10, 15, 20, 25, 30, etc., to the hour specified by the instructor.

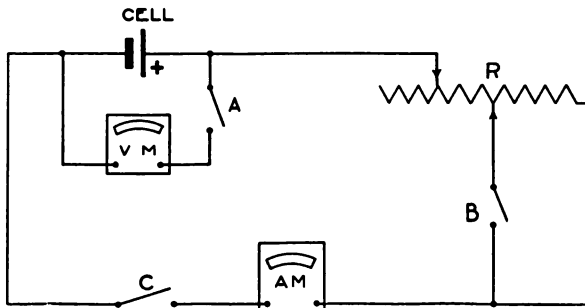

Obtain the virtual internal resistance of the cell at 20-minute intervals, that is just after the regular readings, as follows:

Reduce the current flowing from the cell to about half its normal value by opening switch "B." Note this current and the terminal voltage at the instant and immediately restore the current to the discharge rate used through the test.

$$\text{Internal Resistance } R = \frac{E_1 - E_2}{I_1 - I_2}$$

General Observations: Notice and record throughout the amount of "gasing," stating the time it begins and ends. Notice every five minutes the temperature of the cell. The thermometer bulb should be kept immersed in the electrolyte of the cell. Explain why open circuit voltage changes after charge.

Curves: Construct curves of the terminal voltage during charge and discharge, placing both on the same sheet. Plot time of the abscissae and start both with 0 time as in curve on page 25.

Questions

- (1) How does the voltage change on discharge?
- (2) On charge?
- (3) Why is the terminal voltage on discharge less than open circuit voltage?
- (4) Why is the voltage on charge greater than the open circuit voltage?
- (5) From publications of other manufacturers, individual tests, text books, etc., compare the Alkaline Cells with lead cells.
 - (a) Assuming that internal resistance varies inversely as the rated ampere-hour capacity, compare internal resistance.
 - (b) Maximum possible current of discharge.
 - (c) Limits to rate of charge (boosting).
 - (d) Average voltage on discharge.

Examples

- (1) What voltage would it take to charge fully 60 cells in series at the normal rate?
- (2) What amount of resistance must be in the resistance unit used in series to charge the 60 cells on a 120-volt circuit, assuming a charging rate of 7.5 amp.? (the normal rate for B2 cells).
- (3) What average voltage would these 60 cells give when discharged in series at the normal rate?
- (4) Prove that the equation used to find the virtual internal resistance of the cell is correct.

Observations and Conclusions

THE plates of the Edison Nickel-Iron-Alkaline Storage Battery in any condition of charge, discharge or operation, are not attacked by the electrolyte in which they are submerged.

It is light in weight, compact and durable.

Severe vibration and concussion do not affect it.

Long and often repeated overcharging or charging in the reverse direction causes no permanent injury.

No damage results from remaining idle in a charged or discharged condition indefinitely.

Only a small loss is caused by self-discharge when standing idle.

Short circuiting is not injurious.

It maintains its capacity for many years.

Buckling or growing of its plates are unknown.

The steel jars are unbreakable.

Sulphation or kindred disease is impossible.

Hydrometer readings are necessary only at long intervals to determine if solution needs renewing.

The Edison Battery can be put on charge at any time without detriment, regardless of how little or how much of the previous charge has been used.

It may be taken off charge at any time and used, whether fully charged or not.

It contains no acid and therefore can be located in any convenient place without injury from noxious fumes or corrosion.

The Edison Storage Battery accomplishes the practical elimination of corrosive fumes.

Compare these observations with the characteristics of the *Ideal* storage battery for which we are searching. It must be obvious that the invention of the nickel-iron-alkaline cell was a tremendous step toward the attainment of the *Ideal*.

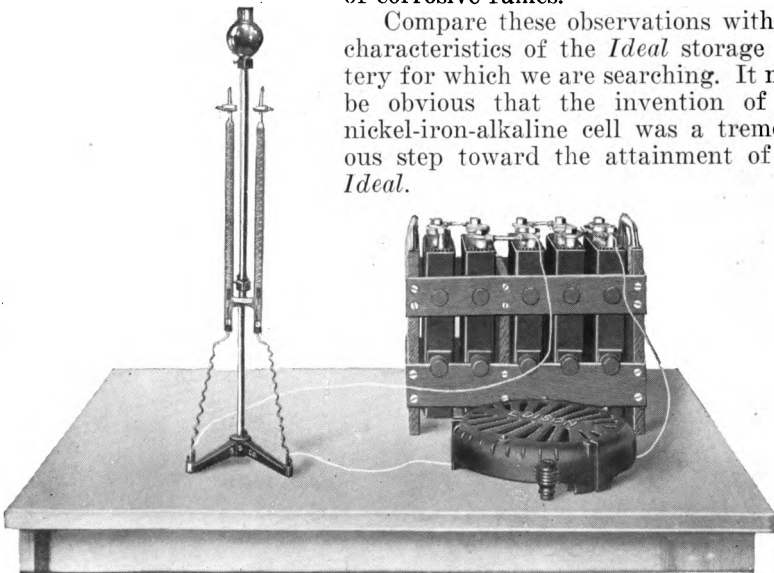

The electrolysis of water. Note that current may be regulated by number of cells used as well as by the rheostat.

Edison Storage Battery Co., Orange, N. J.

General Data and Tray Dimensions of Edison Storage Batteries. (1/4-in. Positive Tubes.)

Type (Letters denote size of Plates)

Figures number of Positive Plates)

Prices on Application

Rated Capacity, Ampere-Hours

Discharge Rate (8-hour) Amperes

Discharge Rate (5-hour) "

Average Discharge Voltage (8-hours)

" (5-hours) "

Normal Charge Rate (7-hours)

Weight of Cell, Complete, pounds

Weight of Cell, in Trays, pounds

Amount Renewal Solution per cell (lbs.)

Over-all Tray Dimensions, in inches

Width of Standard Tray

Height over-all (Filler Cap closed)

Height over-all (Filler Cap open)

Length of Trays: 1-cell Tray

2-cell Tray

3-cell Tray

4-cell Tray

5-cell Tray

6-cell Tray

7-cell Tray

8-cell Tray

9-cell Tray

10-cell Tray

11-cell Tray

12-cell Tray

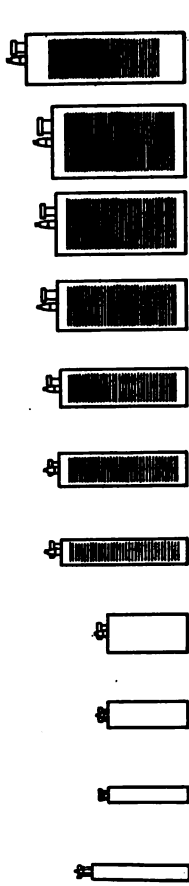

Type	BIH†	B2	B4	B6	A4	A5	A6	A8	A10	A12	A8H†
Rated Capacity, Ampere-Hours	18.75	37.5	75	112.5	150	187.5	225	300	375	450	300
Discharge Rate (8-hour) Amperes	2.34	4.69	9.38	14.06	18.75	23.44	28.13	37.5	46.88	56.25	37.5
Discharge Rate (5-hour) "	3.75	7.5	15	22.5	30	37.5	45	60	75	90	60
Average Discharge Voltage (8-hours)	1.24	1.24	1.24	1.24	1.24	1.24	1.24	1.24	1.24	1.24	1.24
" (5-hours) "	1.2	1.2	1.2	1.2	1.2	1.2	1.2	1.2	1.2	1.2	1.2
Normal Charge Rate (7-hours)	3.75	7.5	15	22.5	30	37.5	45	60	75	90	60
Weight of Cell, Complete, pounds	5.2	4.5	7.8	11.3	13.8	16.7	19.4	26.8	33.3	40.6	30.4
Weight of Cell, in Trays, pounds	5.6	5.1	8.5	12.1	14.9	17.5	20.8	29.0	36.2	43.9	32.1
Amount Renewal Solution per cell (lbs.)	2.0	1.1	1.9	2.7	3.2	3.8	4.3	6.4	8.1	9.9	8.7
Width of Standard Tray	6 1/4	6 1/4	6 1/4	6 1/4	6 1/4	6 1/4	6 1/4	6 1/4	7 3/4	9	6 1/4
Height over-all (Filler Cap closed)	11 1/8	9 5/8	9 5/8	9 5/8	14 3/8	14 3/8	14 3/8	14 3/8	14 3/8	15 1/2	17 1/2
Height over-all (Filler Cap open)	12 3/8	10 5/8	10 5/8	10 7/8	16	16	16	16 3/8	16 3/8	17	19 1/8
Length of Trays: 1-cell Tray	3 1/8	3 1/8	4 1/4	5 3/8	4 5/8	5 1/4	5 1/4	7 1/4	7 1/4	7 1/2	7 1/4
2-cell Tray	5	5	7 7/8	9 3/8	7 3/4	9	10	12 7/8	13 1/2	13 1/2	12 7/8
3-cell Tray	8 1/8	6 7/8	10 1/2	13 1/8	10 7/8	12 3/4	14 1/4	18 1/8	19 1/2	19 1/2	18 1/8
4-cell Tray	10 3/4	10 3/4	16 3/4	22 3/8	17 1/8	20	22 3/4	29 3/4	29 3/4	32 1/4	29 3/4
5-cell Tray	14 1/2	12 3/4	19 7/8	26 3/8	20 1/4	23 1/2	27 3/4	36	36	36	36
6-cell Tray	16 1/2	14 1/2	23	31 1/4	27 1/4	32 1/4	36 1/4	41 1/8	41 1/8	41 1/8	41 5/8
7-cell Tray	18 1/2	16 1/2	26	35 3/8	30 3/8	36	41 1/8	47 1/4	47 1/4	47 1/4	47 1/8
8-cell Tray	20 3/8	18 1/2	29 3/4	41 1/8	33 3/4	40 1/4	45 1/8	53 3/8	53 3/8	53 3/8	53 3/8
9-cell Tray	22 1/4	20 3/8	32 7/8	44 1/8	36 3/8	43 7/8	45 1/8
10-cell Tray	24 3/8	22 1/4	36	47 1/8	40 3/8	48 1/8	45 1/8
11-cell Tray	24 3/8	24 3/8	39	47 1/8	40 3/8	48 1/8	45 1/8
12-cell Tray	24 3/8	24 3/8	39	47 1/8	40 3/8	48 1/8	45 1/8

†The "H" Type has an extra high container allowing for an excess of electrolyte (about 50 or 60 per cent) and permitting longer intervals between "filling." All above types can be furnished with the extra high container if desired. They are designated respectively as B2H, B4H, etc. and have the same electrical characteristics as B2, B4, etc. The difference in height is about 2 3/4 inches on the Type "A," and 1 1/4 inches on the Type "B"—the other dimensions remain identical.

‡Over-all heights are given for bottomless trays. Add 3/4-inch to height and 1/4-inch to length for trays with bottoms.



